



COSTRUZIONE APPARECCHIATURE ELETTRONICHE - OLEODINAMICHE - INDUSTRIALI



42028 - POVIGLIO - (R.E.) - Via Parma, 59 - ITALIA

Tel. +39 0522 960050 (r.a.) - Fax +39 0522 960259 - E-mail: infozapi@tin.it

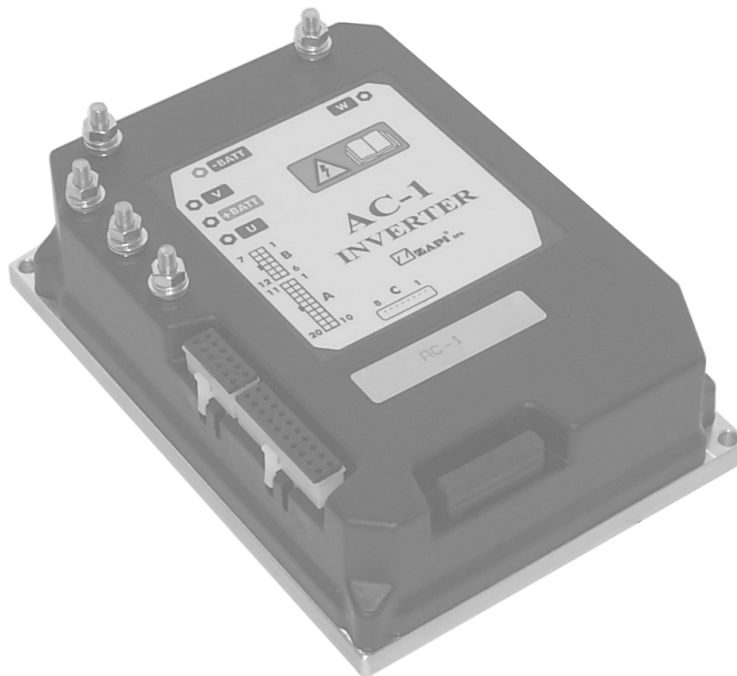
AC1 INVERTER OPERATING HANDBOOK AND FUNCTION DESCRIPTION



INDEX

	Page
1 Introduction	3
2 Specification	3
2.1 Technical specifications	3
2.2 Control unit	4
2.2.a Microswitches	4
2.2.b Accelerator unit	4
2.2.c Other analog control unit	5
2.2.d Speed feedback	5
2.3 Protection features 	6
2.4 Operational features	7
2.5 Diagnosis	8
2.6 Thermal consideration	8
2.7 General instructions and precautions 	8
2.8 Susceptibility and electromagnetic emission 	9
2.9 Main contactor and emergency switch	9
3 Installation	10
3.1 Connection cables	10
3.2 Contactors	10
3.3 Fuses	10
3.4 Description of connectors - Standard version	11
3.5 Description of connectors - MDI PRC Version	13
3.6 Encoder installation	15
3.7 Description of power connections	16
3.8 Mechanical drawing	17
3.9 Connection drawing - Standard Version	18
3.10 Connection drawing - MDI PRC Version	19
4 Programming & Adjustments using Digital Console	20
4.1 Adjustments via Console	20
4.2 Description of Console & Connection	20
4.3 Description of Standard Console Menu	21
4.3.a Standard Version	21
4.3.b MDI PRC Version	22
4.4 Function configuration	23
4.4.a Standard Version	23
4.4.b MDI PRC Version	28
4.5 Parameter regulation: Standard Version	37
4.6 Parameter regulation: MDI PRC Version	39
4.7 Programming console functions	43
4.8 Sequence for Ac Inverter Traction setting	44
4.9 Tester: description of the function; Standard Version	45
4.10 Tester: description of the function; MDI PRC Version	48

5	Other functions	51
5.1	Description of the Console Save function	51
5.2	Description of Console Restore function.	52
5.3	Description of Alarms menu	53
5.4	Description of Console Program Vacc function	54
6	Ac1 Inverter diagnostic	55
6.1	Analysis of alarms displayed on console	55
7	Recommended Spare parts for inverter	60
8	Periodic Maintenance to be repeated at times indicated.	61

 = The informations included into the marked paragraphs by this symbol are essential for the safety.

SIGNATURES TABLE

COMPANY DEPT. SERVICES	MANAGEMENT EXECUTIVE	
ENGINEERING SECTION EXECUTIVE		
EXPORT MANAGER		

Publications N°: **ADTZP0BA**
Edition: **November 2000**

1 INTRODUCTION

Within the ZAPIMOS family, the AC1 inverter is the model suitable for control of 700W to 2.5kW motors. It has been expressly designed for battery electric traction. It is fit for electric transpallet, golf cars, utility cars.

2 SPECIFICATION

2.1 TECHNICAL SPECIFICATIONS

Inverter for AC asynchronous 3-phase motors

Regenerative braking functions

Can-bus interface

Digital control based upon a microcontroller

Voltage: 24 - 36 - 48V

Maximum current (24V,36V): 250A (RMS) for 2'

Maximum current (48V): 180A (RMS) for 2'

Booster (all version) 10% of maximum current for some seconds;

Operating frequency: 8kHz

External temperature range: -30°C ÷ 40°C

Maximum inverter temperature (at full power): 75°C

BLOCK DIAGRAM

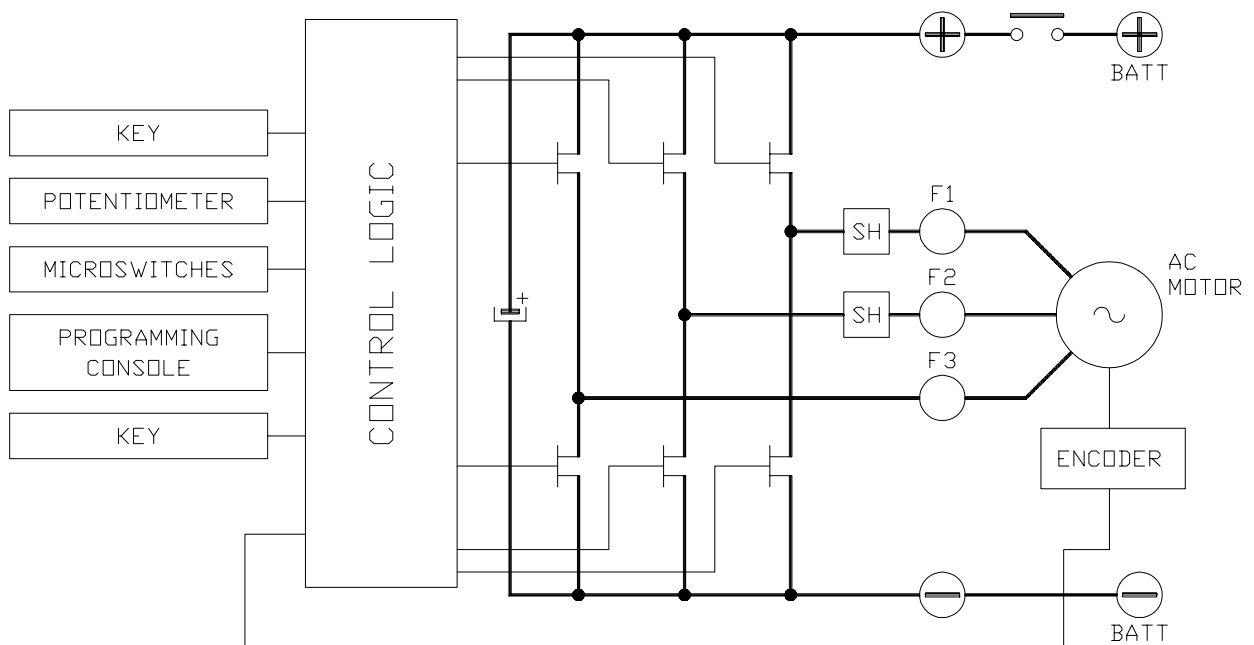

2.2 CONTROL UNIT

2.2.a Microswitches

- The microswitches must have a contact resistance lower than 0.1Ω and a leakage current lower than $100\mu\text{A}$.
- When full load connected, the voltage between the key switch contacts must be lower than 0.1V .
- The microswitches send a voltage signal to the microprocessor when a function request (for ex.: running request) is made.

2.2.b Accelerator unit

The accelerator unit can consist of a potentiometer or an Hall effect device.

It should be in a 3-wire configuration.

CPOT (B10) signal ranges from 0 to 10V.

Potentiometer value should be in the 0.5 - 10 Kohm range; generally, the load should be in the 1.5mA to 30 mA range. Faults can occur if it is outside this range.

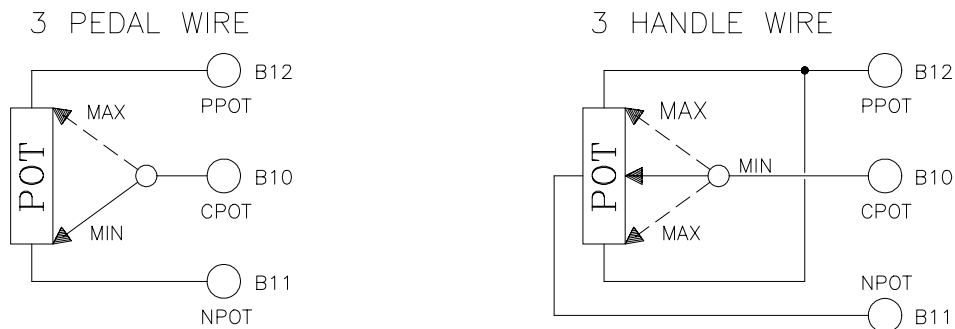

The Procedure for automatic potentiometer signal acquisition is carried out using the Console. This enables adjustment of the minimum and maximum useful signal level (PROGRAM VACC function), in either direction. This function is unique when it is necessary to compensate for asymmetry with the mechanical elements associated with the potentiometer, especially relating to the minimum level.

The sequence of procedure is described in the programming console manual.

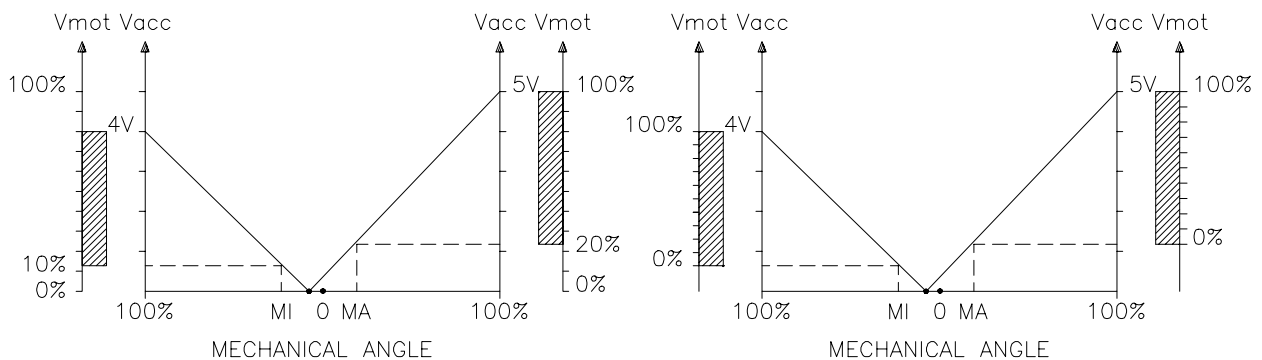

The two graphs show the output voltage from a non-calibrated potentiometer with respect to the mechanical “zero” of the control lever. MI and MA indicate the point where the direction switches close. 0 represents the mechanical zero of the rotation. The Left Hand graph shows the relationship of the motor voltage without signal acquisition being made. The Right Hand Graph shows the same relationship after signal acquisition of the potentiometer.

2.2.c Other analog control unit

Input A18 is an analog input, whose typical application is for proportional braking. It should be in a 3 wire configuration. Potentiometer value should be in the 0.5-10KW range. Generally, the load should be in the 1.5mA to 30 mA range. The CPOTB (A18) signal range is from 0 to 10V.

2.2.d Speed feedback

The motor control is based upon the motor speed feedback. The speed trasducer is an incremental encoder, with two phases shifted at 90°. The encoder can be of different types :

- power supply: +5V or +12V
- electric output: open collector (NPN or PNP), push-pull.

For more details about encoder installation see also chapter 3.6.

2.3 PROTECTION FEATURES

- **Battery polarity inversion:**

It is necessary to fit a MAIN CONTACTOR to protect the inverter against reverse battery polarity and for safety reasons.

- **Connection Errors:**

All inputs are protected against connection errors.

- **Thermal protection**

If the chopper temperature exceeds 75°C, the maximum current is reduced in proportion to the thermal increase. The temperature can never exceeds 100°C.

- **External agents:**

The inverter is protected against dust and the spray of liquid to a degree of protection meeting IP54.

- **Protection against uncontrolled movements:**

The main contactor will not close if:

- The Power unit is not functioning.
- The Logic is not functioning perfectly.
- the output voltage of the accelerator does not fall below the minimum voltage value stored, with 1V added.
- Running microswitch in closed position.

- **Low battery charge:**

when the battery charge is low, the maximum current is reduced to the half of the maximum current programmed.

- **Protection against accidental Start up**

A precise sequence of operations are necessary before the machine will start. Operation cannot begin if these operations are not carried out correctly. Requests for drive, must be made after closing the key switch

2.4 OPERATIONAL FEATURES

- Speed control.
- Optimum behaviour on a slope due to the speed feedback:
 - the motor speed follows the accelerator, starting a regenerative braking if the speed overtakes the speed set-point.
 - the system can perform an electrical stop on a ramp (the machine is electrically hold on a slope) for a programmable time (see also chapter 4)
- Stable speed in every position of the accelerator.
- Regenerative release braking based upon deceleration ramps.
- Regenerative braking when the accelerator pedal is partially released (deceleration).
- Direction inversion with regenerative braking based upon deceleration ramp.
- Regenerative braking and direction inversion without contactors: only the main contactor is present.
- The release braking ramp can be modulated by an analog input, so that a proportional brake feature is obtained.
- Optimum sensitivity at low speeds.
- Voltage boost at the start and with overload to obtain more torque (with current control).
- The inverter can drive an electromechanical brake
- High efficiency of motor and battery due to high frequency commutations.
- Self diagnosis with indication of the fault shown by a flashing led.
- Modification of parameters through the programming console.
- Internal hour-meter with values that can be displayed on the console.
- Memory of the last five alarms with relative hour-meter and temperature displayed on the console.
- Test function within console for checking main parameters.

2.5 DIAGNOSIS

The microprocessor continually monitors the inverter and carries out a diagnostic procedure on the main functions. The diagnosis is made in 4 points

- 1) Diagnosis on key switch closing that checks: watchdog circuit, current sensor, capacitor charging, phase's voltages, contactor drives, can-bus interface, if the switch sequence for operation is correct and if the output of accelerator unit is correct.
- 2) Standby diagnosis at rest that checks: watchdog circuit, phase's voltages, contactor driver, current sensor, can-bus interface.
- 3) Diagnosis during operation that checks: watchdog circuits, contactor driver, current sensors, can-bus interface.
- 4) Continuous diagnosis that check: temperature of the inverter, motor temperature.

Diagnosis is provided in two ways. The digital console can be used, which gives a detailed information about the failure; the failure code is also sent on the Can-Bus.

2.6 THERMAL CONSIDERATION

- The heat generated by the power block must be dissipated. For this to be possible, the compartment must be ventilated and the heat sink materials ample.
- The heat sink material and system should be sized on the performance requirement of the machine. Abnormal ambient air temperatures should be considered. In situations where either ventilation is poor, or heat exchange is difficult, forced air ventilation should be used.
- The thermal energy dissipated by the power block module varies and is dependent on the current drawn and the duty cycle.

2.7 GENERAL INSTRUCTIONS AND PRECAUTIONS .

- Never connect SCR low frequency chopper with ASYNCHRONOUS INVERTER because the ASYNCHRONOUS filter capacitors alter the SCR choppers' work. If it is necessary to use two or more control units (traction + lift. for ex.), they must belong to the ZAPIMOS family.
- Do not connect the inverter to a battery with a nominal value different from the value indicated on the chopper plate. If the battery value is greater, the MOS may fail; if it is lower, the control unit does not "power up".
- During battery charge, disconnect ASYNCHRONOUS from the battery.
- Supply the ASYNCHRONOUS only with battery for traction; do not use a power supply.
- When the chopper is installed, make tests with the wheels raised from the ground, in order to avoid dangerous situations due to connection errors.
- After the chopper is switched off (key off), the filter capacitor remains charged for some minutes; if you need to work on the inverter, discharge them using a $10\Omega \div 100\Omega$ resistance connected from the +Batt to the -Batt.

2.8 SUSCEPTIBILITY AND ELECTROMAGNETIC EMISSION

Electromagnetic susceptibility and emission are strongly influenced by the installation. Special attention must be given to the lengths and the paths of the electric connections and the shields.

This situation is beyond ZAPI's control. Therefore ZAPI declines any responsibility for noncompliance if correct testing is not made (the irradiated emission directive is EN50081-2).

2.9 MAIN CONTACTOR AND EMERGENCY SWITCH

- The connection of the battery line switches must be carried out following ZAPI instructions.
- If a mechanical battery line switch is installed, it is necessary that the key supply to the inverter is open together with power battery line; if not, the inverter may be damaged if the switch is opened during a regenerative braking.

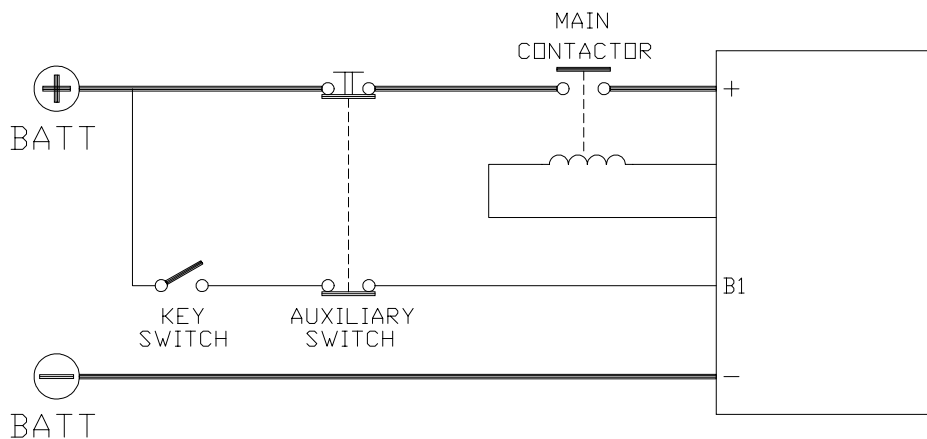

- An intrinsic protection is present inside the logic when the voltage on the battery power connection overtakes 40% more than the battery nominal voltage or if the key is switched off before the battery power line is disconnected.

3 INSTALLATION

Install the chopper with the base-plate on a flat metallic surface that is clean and unpainted. Apply a light layer of thermo-conductive grease between the two surfaces to permit better heat dissipation.

Ensure that the wiring of the cable terminals and connectors is carried out correctly. Fit transient suppression devices to the horn, solenoid valves, and contactors not connected to the chopper such as those for activating the pump motor or steering motor.

3.1 CONNECTION CABLES

For the auxiliary circuits, use cables of 0.5mm² section.

For power connections to the motor and to the battery, use cables having section of 16 mm² (as a minimum).

For the optimum inverter performance, the cables to the battery should be run side by side and be as short as possible.

3.2 CONTACTORS

The main contactor must be installed. Depending on the setting of a parameter (see option menu):

- the output which drives the main contactor coil is on/off (the coil is driven with the full battery voltage).
- the output which drives the main contactor coil is switched at high frequency (1 KHz) with a programmable duty cycle; this feature is useful to decrease the power dissipation of the contactor coil.

3.3 FUSES

- Use a 6.3A Fuse for protection of the auxiliary circuits.
- For protection of the power unit, refer to diagrams.. The Fuse value shown is the maximum allowable. For special applications or requirements these values can be reduced.
- For Safety reasons, we recommend the use of protected fuses in order to prevent the spread of fused particles should the fuse blow.

3.4 DESCRIPTION OF CONNECTORS - STANDARD VERSION

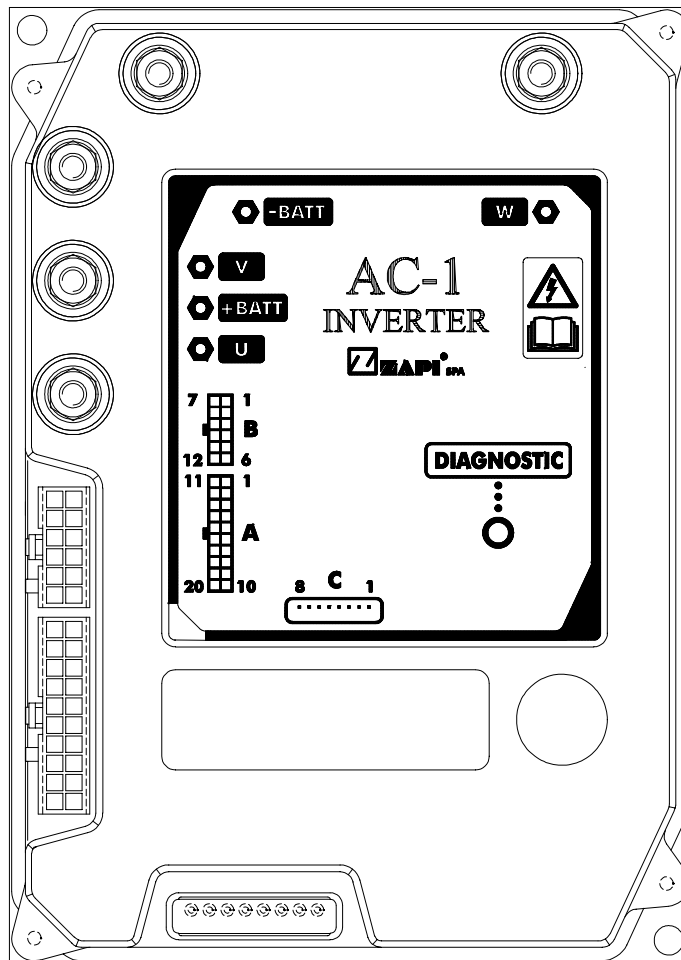

A1	NLC	Negative of main contactor coil.
A2	PLC , PEB	Positive of main contactor coil and electromechanical brake coil.
A3	NBRAKE	Output for driving the electromechanical brake coil; drives the load to -Batt. Maximum current : 3A.
A4	NPC	Negative of pump contactor coil.
A5	PPC , PEV	Positive of pump contactor coil and lowering electrovalve coil.
A6	NEV	Negative of the lowering electrovalve coil.
A7	CAN-L	Low level CAN-BUS voltage I/O.
A8	NPOTB	-Batt.
A9	ENCODER	Incremental ENCODER (see chapter 3.6).
A10	ENCODER	Incremental ENCODER (see chapter 3.6).
A11	HM	Output for driving an hourmeter; when the hourmeter is active this output provides a +Batt signal; 3A maximum current.
A12	-BATT	-Batt.
A13	SR1	Speed reduction 1 input. Active low (switch opened).
A14	SR2	Speed reduction 2 input. Active low (switch opened).

A15	SR3	Speed reduction 3 input. Active low (switch opened).
A16	+12V	This output provides a +12V signal for thr MDI PRC, if present; 100mA maximum current.
A17	CAN-H	High level CAN-BUS voltage I/O.
A18	CPOTB	Brake potentiometer wiper.
A19	ENCODER	Incremental ENCODER (see chapter 3.6).
A20	ENCODER	Incremental ENCODER (see chapter 3.6).
B1	KEY	Connected to the power supply through a microswitch (KEY) with a 10A fuse in series.
B2	CM	Common of FW / BW / SR1 / SR2 / SR3 / TILLER / H&S / BELLY / LIFTING / LOWERING microswitches.
B3	TILLER	Tiller request input. Must be connected to the tiller microswitch, active high.
B4	H&S	Hard & Soft request input. Must be connected to the Hard & Soft microswitch, active high.
B5	BACKWARD	Backward direction request input. Must be connected to the backward direction microswitch, active high.
B6	FORWARD	Forward direction request input. Must be connected to the forward direction microswitch, active high.
B7	BELLY	Quick inversion function input; must be connected to the Belly microswitch; it is active high.
B8	LOWERING	Lowering request input, active high.
B9	LIFTING	Lifting request input, active high.
B10	CPOT	Accelerator potentiometer wiper.
B11	NPOT	Negative of accelerator unit, tested for wire disconnection diagnosis.
B12	PPOT	Potentiometer positive: 10V output; keep load > 1KΩ.
C1	PCLRXD	Positive serial reception.
C2	NCLRXD	Negative serial reception.
C3	PCLTXD	Positive serial transmission.
C4	NCLTXD	Negative serial transmission.
C5	GND	Negative console power supply.
C6	+12	Positive console power supply.
C7	FLASH	Must be connected to C8 for the Flash memory programming (if used).
C8	FLASH	Must be connected to C7 for the Flash memory programming (if used).

3.5 DESCRIPTION OF CONNECTORS - MDI PRC VERSION

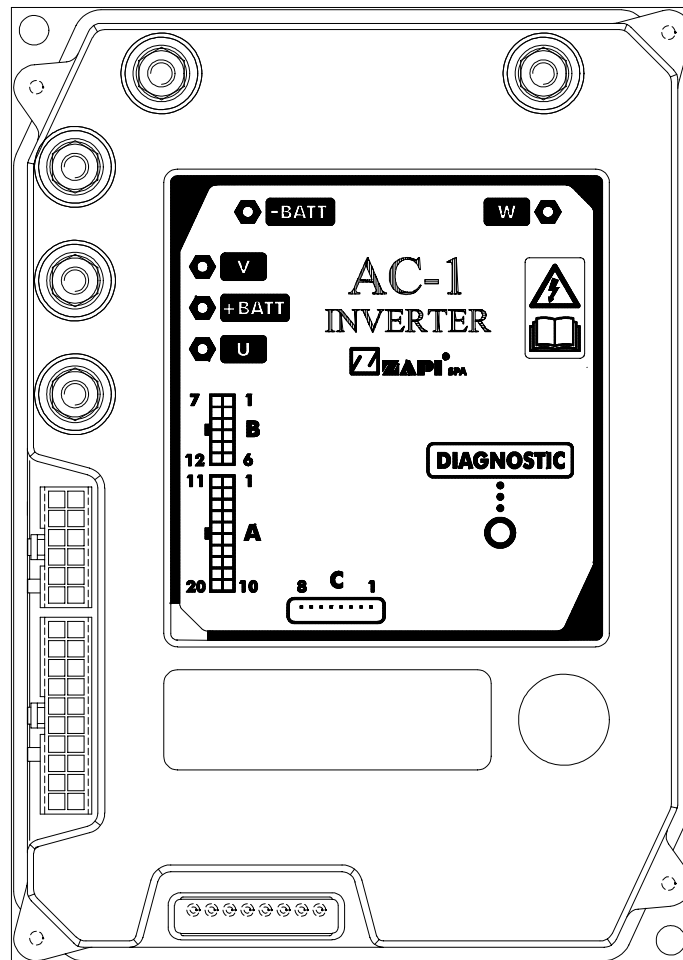

A1	NLC	Negative of main contactor coil.
A2	PLC , PEB	Positive of main contactor coil and electromechanical brake coil.
A3	NBRAKE	Output for driving the electromechanical brake coil; drives the load to -Batt. Maximum current : 3A.
A4	NPC	Negative of pump contactor coil.
A5	PPC , PEV	Positive of pump contactor coil the auxiliary output load.
A6	NEV	Negative of the auxiliary output.
A7	CAN-L	Low level CAN-BUS voltage I/O.
A8	NPOTB	-Batt.
A9	ENCODER	Incremental ENCODER (see chapter 3.6).
A10	ENCODER	Incremental ENCODER (see chapter 3.6).
A11	PEV (+B)	This output provides a +Batt for the electrovalves coils connected to the MDI PRC; 3A maximum current.
A12	-BATT	-Batt.
A13	SR1	Speed reduction 1 input. Active low (switch opened).
A14	LIFT AUX.	Auxiliary lifting request input, active high.

A15	LOW AUX.	Auxiliary lowering request input, active high.
A16	+12V	This output provides a +12V signal for thr MDI PRC; 100mA maximum current.
A17	CAN-H	High level CAN-BUS voltage I/O.
A18	CPOTB	Proprtional electrovalves potentiometer wiper.
A19	ENCODER	Incremental ENCODER (see chapter 3.6).
A20	ENCODER	Incremental ENCODER (see chapter 3.6).
B1	KEY	Connected to the power supply through a microswitch (KEY) with a 10A fuse in series.
B2	CM	Common of FW / BW / SR1 / LIFT AUX / LOW AUX / TILLER / H&S / BELLY / LIFTING / LOWERING microswitches.
B3	TILLER	Tiller request input. Must be connected to the tiller microswitch, active high.
B4	H&S	Hard & Soft request input. Must be connected to the Hard & Soft microswitch, active high.
B5	BACKWARD	Backward direction request input. Must be connected to the backward direction microswitch, active high.
B6	FORWARD	Forward direction request input. Must be connected to the forward direction microswitch, active high.
B7	BELLY	Quick inversion function input; must be connected to the Belly microswitch; it is active high.
B8	LOWERING	Lowering request input, active high.
B9	LIFTING	Lifting request input, active high.
B10	CPOT	Accelerator potentiometer wiper.
B11	NPOT	Negative of accelerator unit, tested for wire disconnection diagnosis.
B12	PPOT	Potentiometer positive: 10V output; keep load > 1K Ω .
C1	PCLRxD	Positive serial reception.
C2	NCLRxD	Negative serial reception.
C3	PCLTxD	Positive serial transmission.
C4	NCLTxD	Negative serial transmission.
C5	GND	Negative console power supply.
C6	+12	Positive console power supply.
C7	FLASH	Must be connected to C8 for the Flash memory programming (if used).
C8	FLASH	Must be connected to C7 for the Flash memory programming (if used).

3.6 ENCODER INSTALLATION

1) AC1 card is fit for different types of encoder. To control AC motor with Zapi inverter, it is necessary to install an incremental encoder with 2 phases shifted of 90°. The encoder power supply can be +5 or +12V. It can have different electronic output.

A9	+5V/+12V	positive of encoder power supply.
A10	GND	negative of encoder power supply.
A19	A	phase A of encoder.
A20	B	phase B of encoder.

2) Connection of encoder with open collector output; +5V power supply.

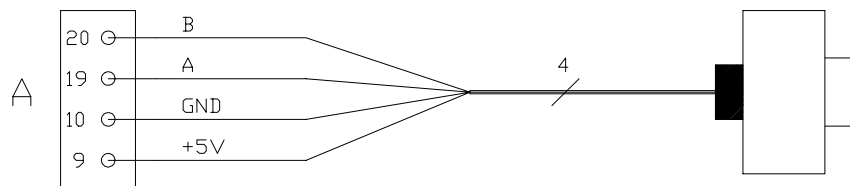

3) Connection of encoder with open collector output: +12V power supply.

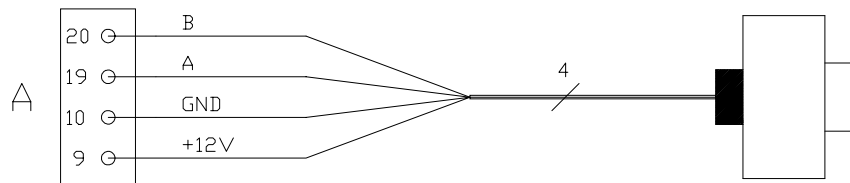

VERY IMPORTANT

It is necessary to specify in the order the type of encoder used, in terms of power supply, electronic output and n° of pulses for revolution, because the logic unit must be set in the correct way by Zapi.

3.7 DESCRIPTION OF POWER CONNECTIONS

View of the power bars:

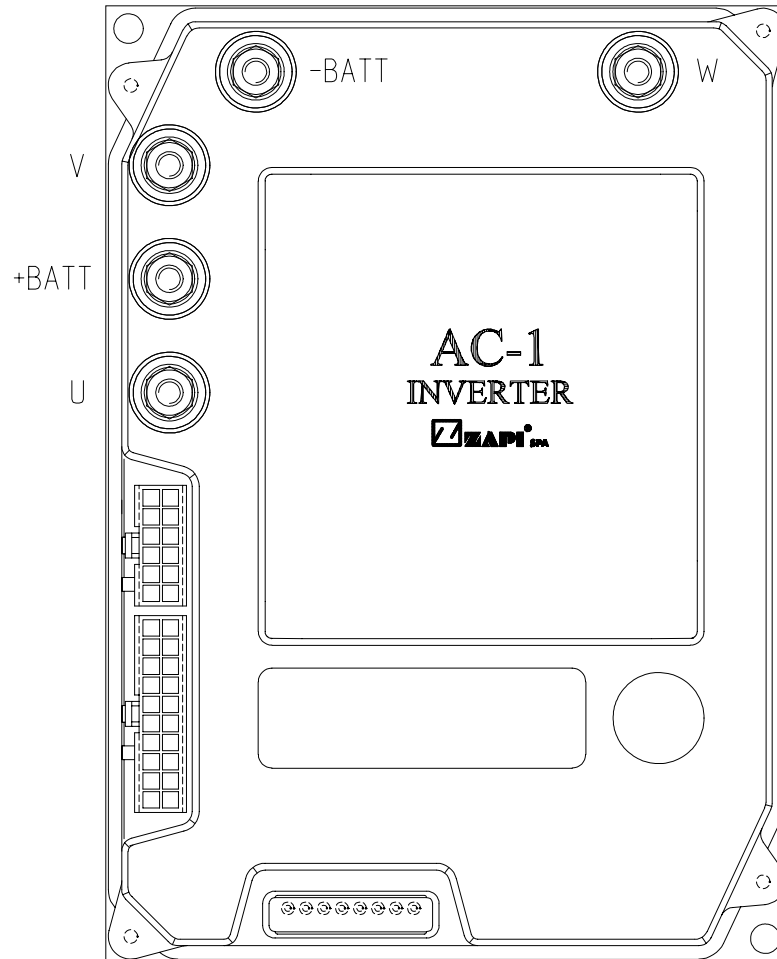

- BATT Negative of the battery.
- +BATT Positive of the battery.
- U; V; W Connection bars of the three motor phases; follow this sequence and the indication on the motor.

3.8 MECHANICAL DRAWING

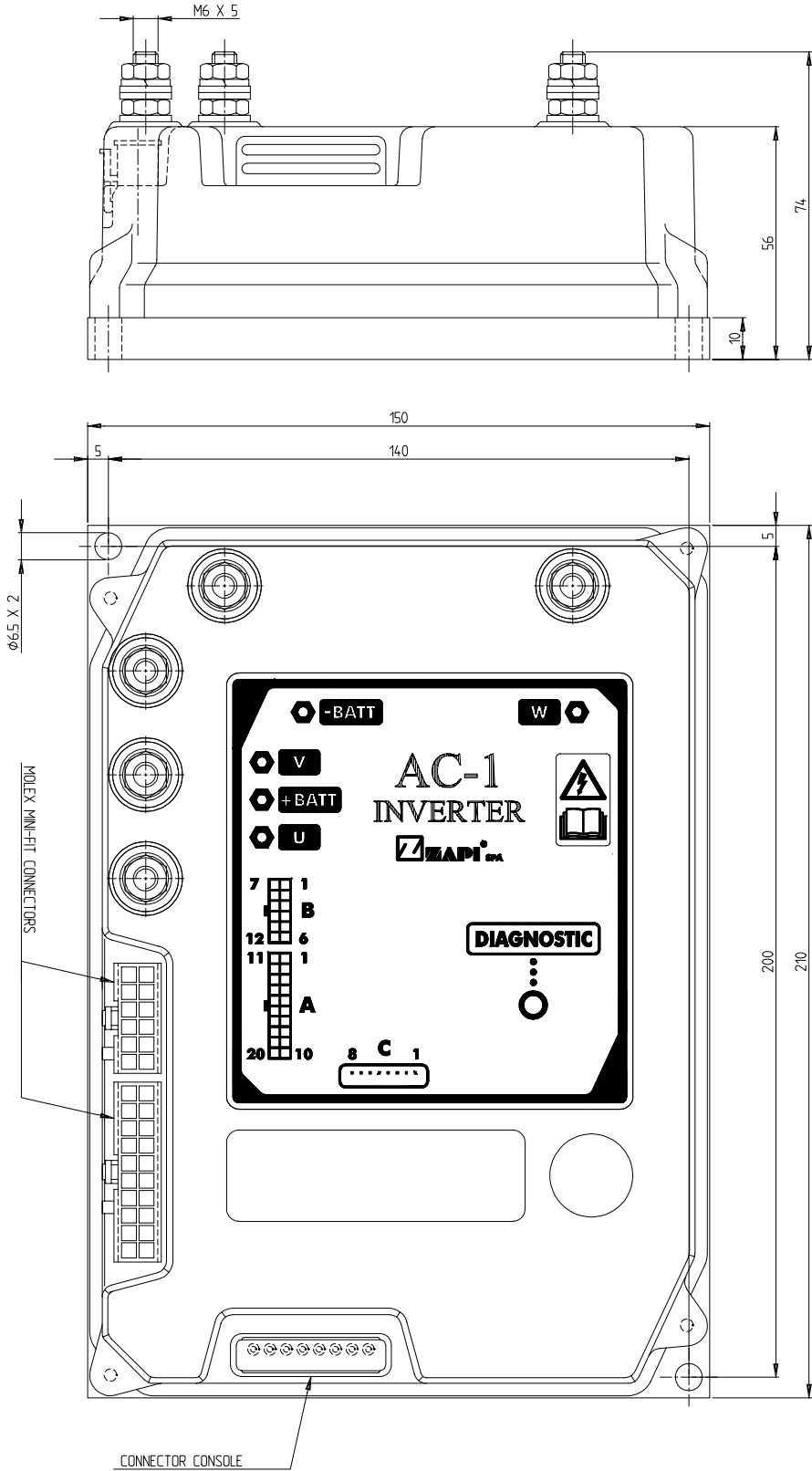

3.9 CONNECTION DRAWING - STANDARD VERSION

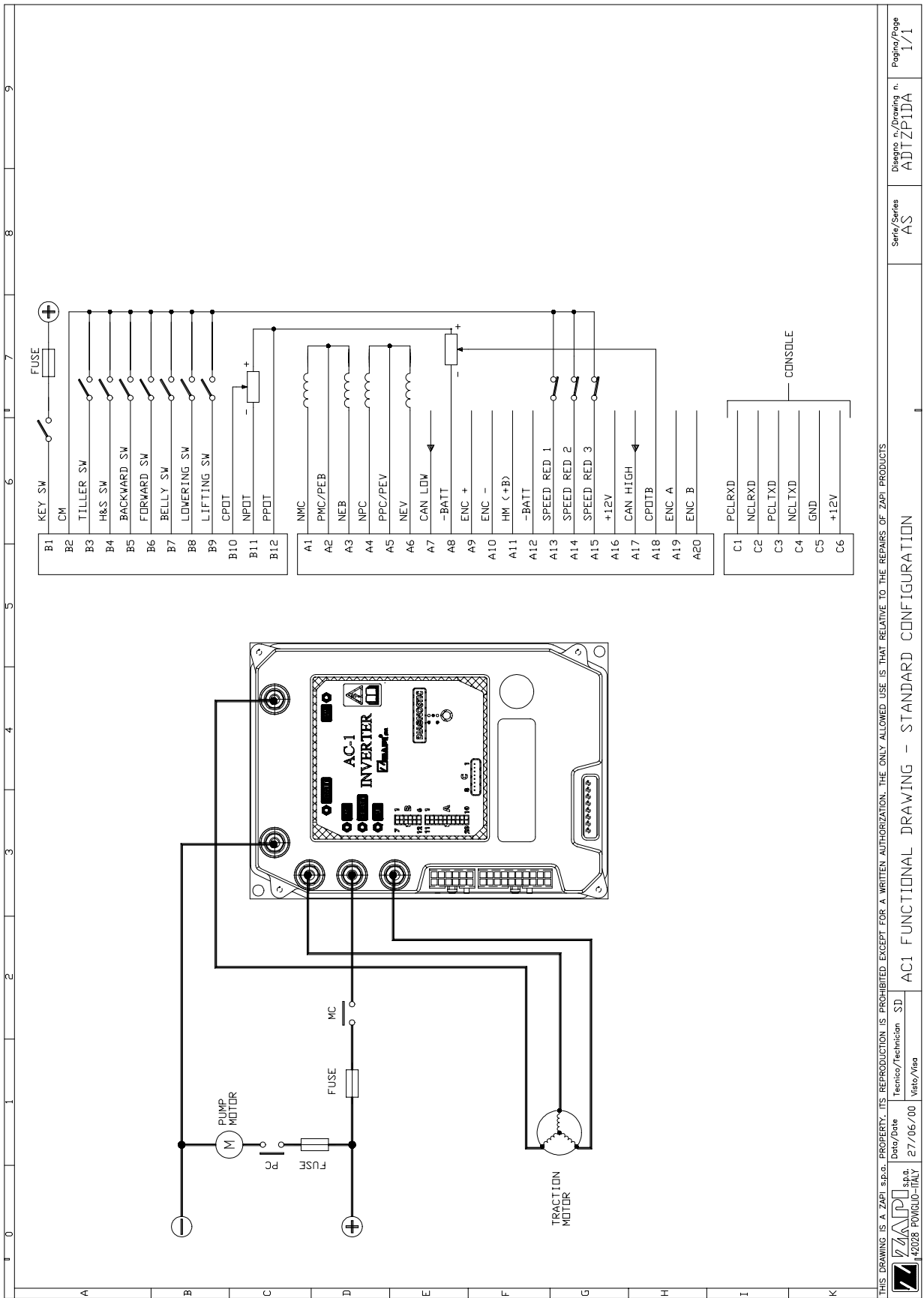

THIS DRAWING IS A ZAPF s.p.a. PROPERTY. ITS REPRODUCTION IS PROHIBITED EXCEPT FOR A WRITTEN AUTHORIZATION. THE ONLY ALLOWED USE IS THAT RELATIVE TO THE REPAIRS OF ZAPF PRODUCTS.

ZAPF s.p.a. 42028 PONGILO-ITALY	Date/Date 27/05/00	Technico/Technician SD Vesto/Vesa
Series/Series AS	Design n./Drawing n. ADT2PIDA	Pagina/Page 1/1

3.10 CONNECTION DRAWING - MDI PRC VERSION

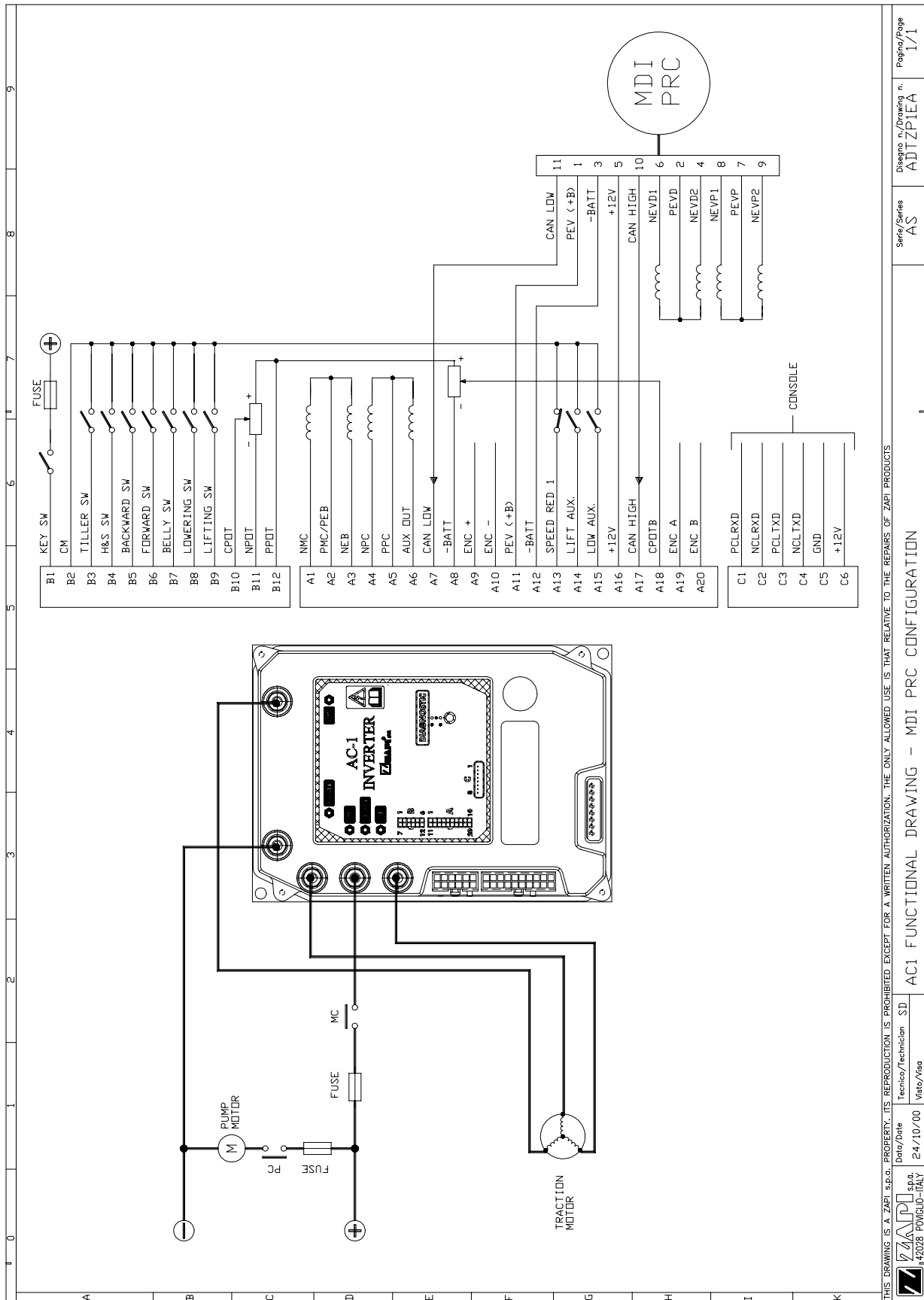

THIS DRAWING IS A ZAPF S.p.A. PROPERTY. ITS REPRODUCTION IS PROHIBITED EXCEPT FOR A WRITTEN AUTHORIZATION. THE ONLY ALLOWED USE IS THAT RELATIVE TO THE REPAIRS OF ZAPF PRODUCTS

 s.p.a.
 #42028 PAVIGLIO-ITALY
 Date/Date 24/10/00
 Technician/tecnico SD
 Works/Office

AC1 FUNCTIONAL DRAWING - MDI PRC CONFIGURATION

Safety/Series AS
 Design n./drawing n. ADTZPIEA
 Page/Page 1/1

4 PROGRAMMING & ADJUSTMENTS USING DIGITAL CONSOLE

4.1 ADJUSTMENTS VIA CONSOLE

Adjustment of Parameters and changes to the inverter's configuration are made using the Digital Console. The Console is connected to the "C" connector of the inverter.

4.2 DESCRIPTION OF CONSOLE & CONNECTION

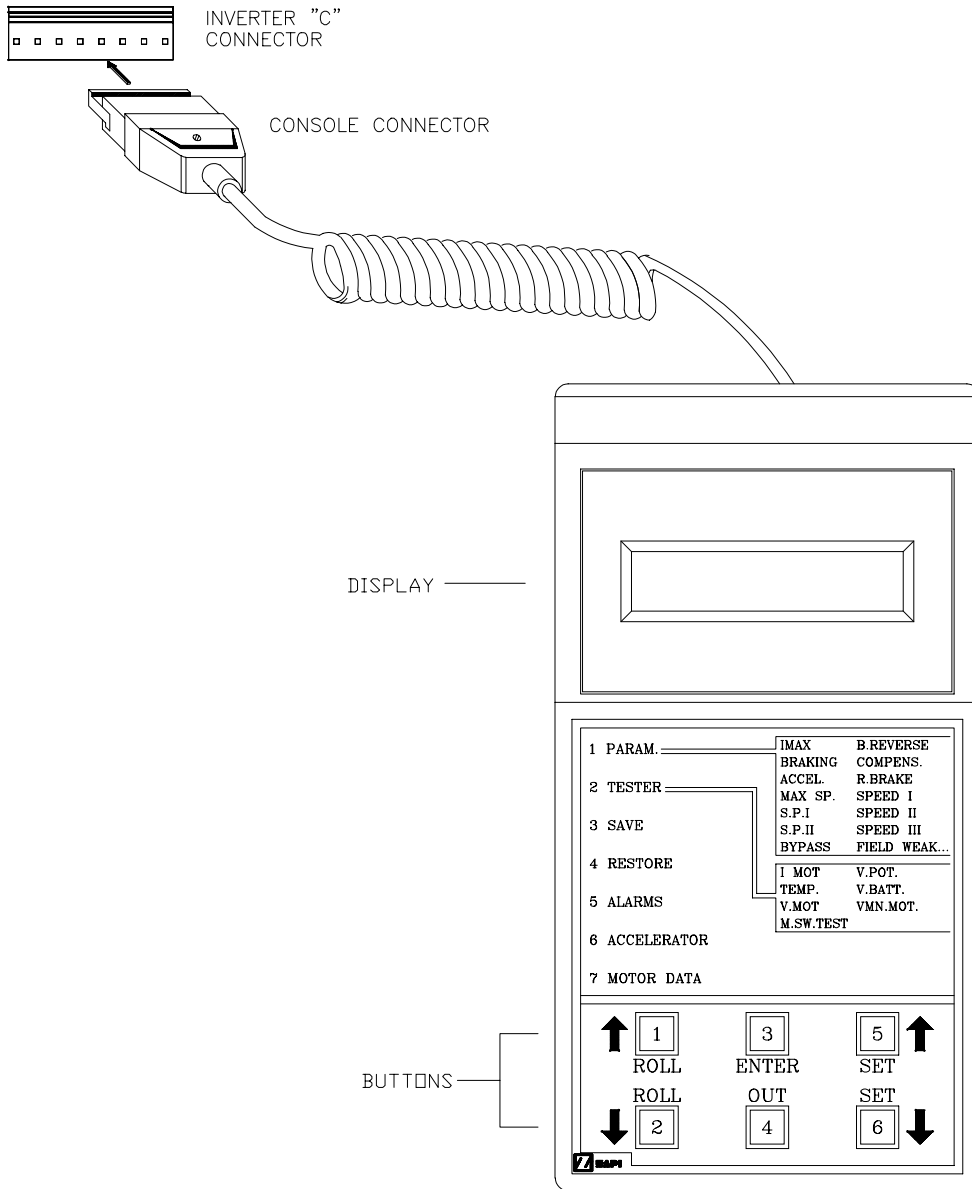

Digital consoles used to communicate with AC inverter controllers must be fitted with EPROM CK ULTRA, minimum "Release Number 3.02".

4.3 DESCRIPTION OF STANDARD CONSOLE MENU

4.3.a Standard Version

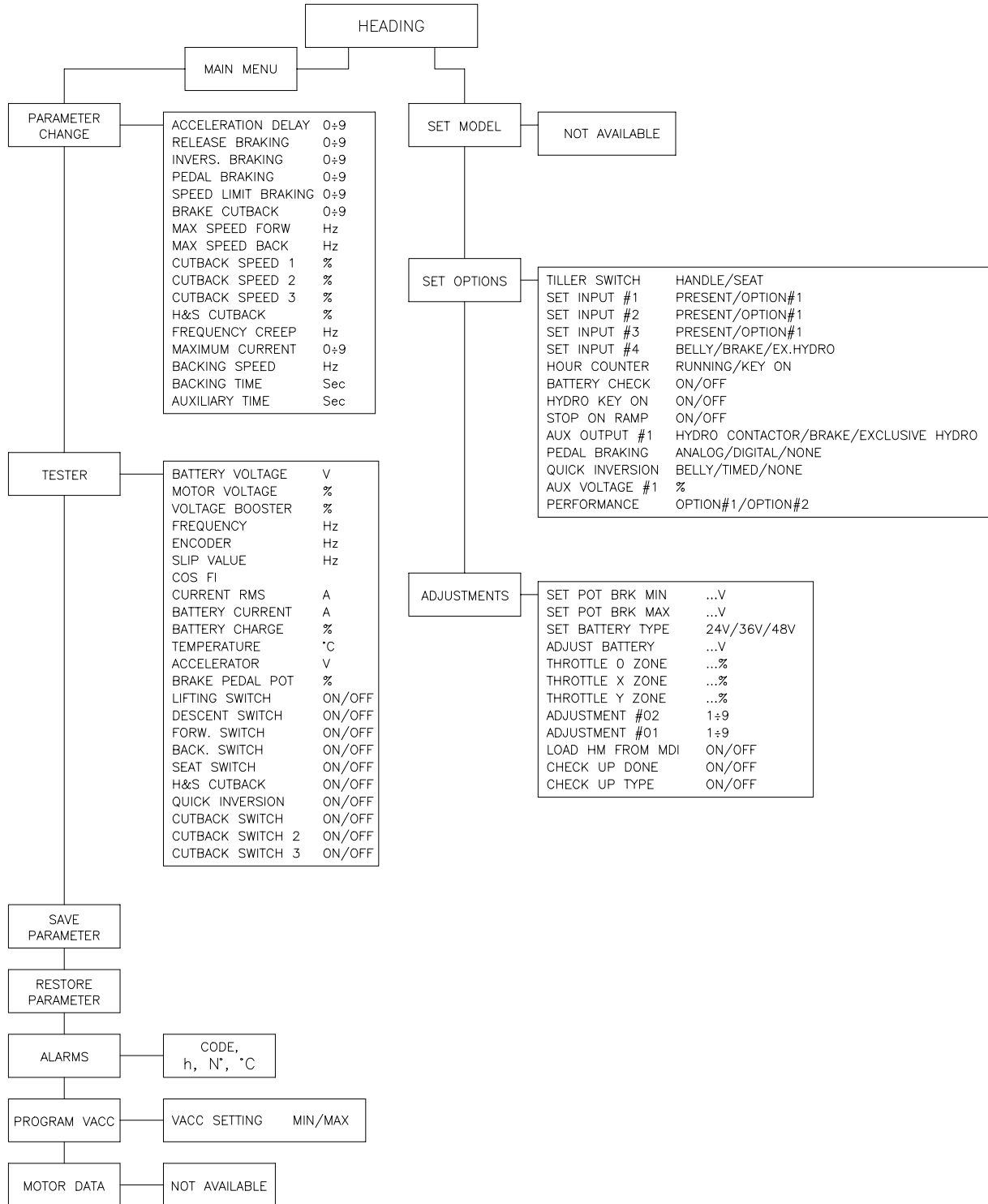

4.3.b MDI PRC Version

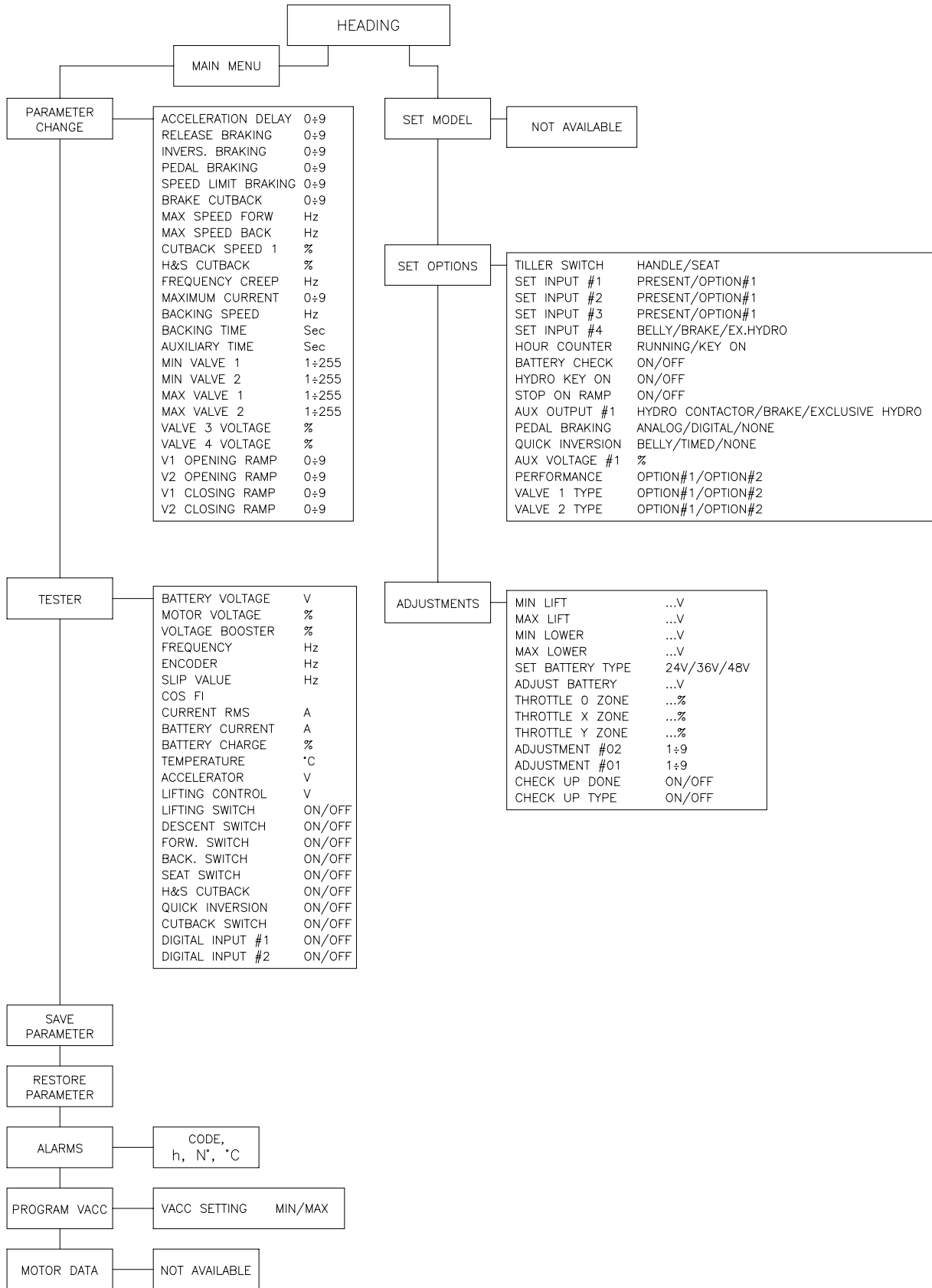

4.4 FUNCTION CONFIGURATION

4.4.a Standard Version

SUBMENU "SET OPTIONS"

1 TILLER SWITCH

- HANDLE input B3 is managed as a tiller input.
- SEAT input B3 is managed as a seat input.

2 SET INPUT #1

- PRESENT: input A13 is managed as a cutback speed input.
- OPTION #1: input A13 is managed as an handbrake input.

3 SET INPUT #2

- PRESENT: input A14 is managed as a cutback speed input.
- OPTION #1: input A14 is managed as an "Inching Forward" input.

4 SET INPUT #3

- PRESENT: input A15 is managed as a cutback speed input.
- OPTION #1: input A15 is managed as an "Inching Backward" input.

5 SET INPUT #4

- BELLY: input B7 is managed as a belly input.
- BRAKE: input B7 is managed as a service brake input.
- EX. HYDRO: input B7 is managed as a "Exclusive Hydro" input.

6 HOUR COUNTER

- RUNNING: the counter registers travel time only.
- KEY ON: the counter registers when the "key" switch is closed.

7 BATTERY CHECK

- ON: the battery discharge level check is carried out; when the battery level reaches 10%, an alarm is signalled and the maximum current is reduced to the half of the programmed value.
- OFF: the battery discharge level check is carried out but no alarm is signalled.

8 HYDRO KEY ON

- ON / OFF: if this option is programmed ON the traction inverter manages an hydraulic steering function when the "key" is switched ON (only if the "aux output #1" option is programmed as "hydro contactor" or as "exclusive hydro").

9 STOP ON RAMP

- ON: the stop on ramp feature (truck electrically hold on a ramp) is managed for a time established by "auxiliary time" parameter. After this time, the behaviour depends on the "aux output #1" option programming (see also the following table).
- OFF: the stop on ramp feature is not performed.

10 AUX OUTPUT #1

- BRAKE: output A3 drives an electromagnetic brake coil (see also the table below).
- HYDRO CONT.: the inverter manages an hydraulic steering function when the direction input or brake pedal input are active or a movement of the truck is detected.
- EX. HYDRO: output A3 drives an hydraulic steering function when the exclusive hydro input is active.

11 PEDAL BRAKING

- ANALOG:
 - Option "Set input #4" programmed "Belly":
the mechanical brake pedal has a potentiometer installed. When the accelerator is released and the pedal brake is pushed the inverter performs an electrical braking whose intensity is proportional to the brake pedal potentiometer. The minimum intensity is established by the "Release braking" parameter, when the brake pedal is slightly pressed (brake potentiometer at the minimum). The maximum intensity is established by the "Pedal braking" parameter when the brake pedal is fully pressed (brake potentiometer at the maximum). In the middle positions, the electrical braking intensity is a linear function between minimum and maximum intensity.
 - Option "Set input #4" programmed "Brake":
the mechanical brake pedal has a switch and a potentiometer installed. When the accelerator is released and the pedal brake is pushed the inverter performs an electrical braking whose intensity is proportional to the brake pedal potentiometer. The minimum intensity is established by the "Release braking" parameter, when the brake pedal is slightly pressed (brake switch closed but brake potentiometer at the minimum). The maximum intensity is established by the "Pedal braking" parameter when the brake pedal is fully pressed (brake potentiometer at the maximum). In the middle positions, the electrical braking intensity is a linear function between minimum and maximum intensity.
- DIGITAL: The truck does not have a potentiometer installed on the mechanical brake pedal, but only a microswitch; when the accelerator pedal is released and the brake pedal is pushed (brake switch closed), the inverter performs an electrical braking following "Pedal braking" parameter.

- NONE: Means that there aren't any switch or potentiometer installed on the brake.

12 QUICK INVERSION

- NONE The quick inversion function is not managed.
- TIMED The quick inversion function is timed.
- BELLY The quick inversion function is managed but not timed.

13 AUX VOLTAGE #1

- % this parameter permits to program the supply voltage of the main contactor coil and the electromechanical brake.

14 PERFORMANCE

- OPTION #1 Set of parameter which determines a "Low Performance".
- OPTION #2 Set of parameter which determines a "High Performance".

SOTTOMENU' "ADJUSTMENT"

- 1 SET POT BRK MIN: records the minimum value of braking pedal potentiometer when the braking pedal switch is closed; the procedure is similar to the "Program Vacc" function (see chapter 5.4). This procedure must be carried out only if the "Pedal braking" option is programmed as "Analog".
- 2 SET POT BRK MAX: records the maximum value of braking pedal potentiometer when the braking pedal is fully pressed; the procedure is similar to the "Program Vacc" function (see chapter 5.4). This procedure must be carried out only if the "Pedal braking" option is programmed as "Analog".
- 3 SET BATTERY TYPE: selects the nominal battery voltage;
- 4 ADJUST BATTERY: fine adjustment of the battery voltage measured by the controller.
- 5 THROTTLE 0 ZONE: establishes a deadband in the accelerator input curve (see also curve below).
- 6 THROTTLE X POINT: These parameter change the characteristic of the accelerator input curve.

7 THROTTLE Y POINT: These parameter change the characteristic of the accelerator input curve.

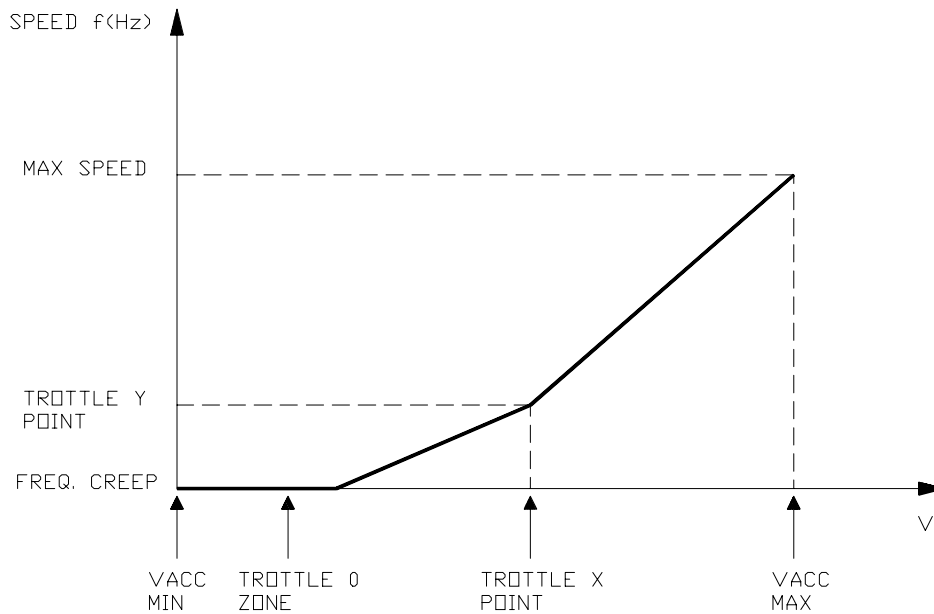

VACC MIN and VACC MAX are values programmable by the "Program Vacc" function.

8 ADJUSTMENT #01: adjust the upper level of the battery discharge table.

9 ADJUSTMENT #02: adjust the lower level of the battery discharge table.

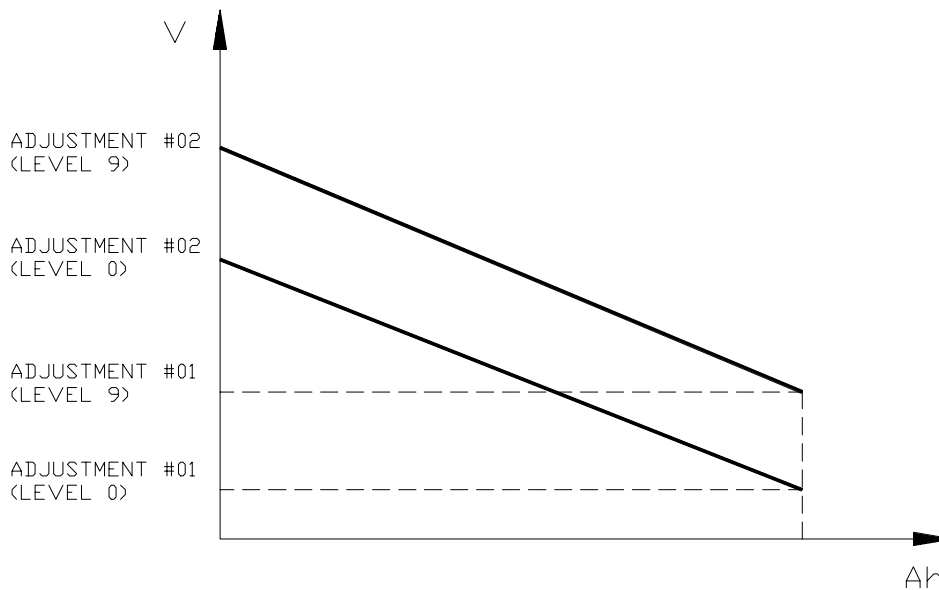

10 LOAD HM FROM MDI: for an explanation of this point see the MDI instrument handbook

11 CHECK UP DONE: for an explanation of this point see the MDI instrument handbook

12 CHECK UP TYPE: for an explanation of this point see the MDI instrument handbook

AUX OUTPUT	STOP ON RAMP	A3 OUTPUT	BEHAVIOUR ON A SLOPE
BRAKE	ON	-Drives the coil of a electromagnetic brake.	The truck is electrically hold on a slope; when the time set by "auxiliary time" parameter is elapsed the brake is applied and the 3-phase bridge is released. <u>Do not use this combination if the negative brake is not installed.</u>
BRAKE	OFF	-Drives the coil of a electromagnetic brake.	The truck is not electrically hold on a slope, but comes down very slowly; when the time set by "auxiliary time" parameter is elapsed, the brake is applied and the 3-phase bridge is opened. <u>Do not use this combination if the negative brake is not installed.</u>
HYDRO CONT.	ON	-Drives the coil of a hydraulic steering contactor.	The truck is electrically hold on a slope; when the time set by "auxiliary time" parameter is elapsed, the truck comes down very slowly, till the flat is reached.
HYDRO CONT.	OFF	-Drives the coil of a hydraulic steering contactor.	The truck is not electrically hold on a slope, but comes down very slowly till the flat is reached.
EXCL. HYDRO	ON	-Drives the coil of a hydraulic steering contactor.	The truck is electrically hold on a slope; when the time set by "auxiliary time" parameter is elapsed, the truck comes down very slowly, till the flat is reached.
EXCL. HYDRO	OFF	-Drives the coil of a hydraulic steering contactor.	The truck is not electrically hold on a slope, but comes down very slowly till the flat is reached.

4.4.b MDI PRC Version

SUBMENU "SET OPTIONS"

1 TILLER SWITCH

- HANDLE input B3 is managed as a tiller input.
- SEAT input B3 is managed as a seat input.

2 SET INPUT #1

- PRESENT: input A13 is managed as a cutback speed input.
- OPTION #1: input A13 is managed as an handbrake input.

3 SET INPUT #4

- BELLY: input B7 is managed as a belly input.
- BRAKE: input B7 is managed as a service brake input.
- EX. HYDRO: input B7 is managed as a "Exclusive Hydro" input.

4 HOUR COUNTER

- RUNNING: the counter registers travel time only.
- KEY ON: the counter registers when the "key" switch is closed.

5 BATTERY CHECK

- ON: the battery discharge level check is carried out; when the battery level reaches 10%, an allarm is signalled and the maximum current is reduced to the half of the programmed value.
- OFF: the battery discharge level check is carried out but no allarm is signalled.

6 HYDRO KEY ON

- ON / OFF: if this option is programmed ON the traction inverter manages an hydraulic steering function when the "key" is switched ON (only if the "aux output #1" option is programmed as "hydro contactor" or as "exclusive hydro").

7 STOP ON RAMP

- ON: the stop on ramp feature (truck electrically hold on a ramp) is managed for a time established by "auxiliary time" parameter. After this time, the behaviour depends on the "aux output #1" option programming (see also the following table).
- OFF: the stop on ramp feature is not performed.

8 AUX OUTPUT #1

- BRAKE: output A3 drives an electromagnetic brake coil (see also the table below).
- HYDRO CONT.: the inverter manages an hydraulic steering function when the direction input or brake pedal input are active or a movement of the truck is detected.
- EX. HYDRO: output A3 drives an hydraulic steering function when the exclusive hydro input is active.

9 PEDAL BRAKING

- ANALOG: Option "Set input #4" programmed "Belly":
the mechanical brake pedal has a potentiometer installed. When the accelerator is released and the pedal brake is pushed the inverter performs an electrical braking whose intensity is proportional to the brake pedal potentiometer. The minimum intensity is established by the "Release braking" parameter, when the brake pedal is slightly pressed (brake potentiometer at the minimum). The maximum intensity is established by the "Pedal braking" parameter when the brake pedal is fully pressed (brake potentiometer at the maximum). In the middle positions, the electrical braking intensity is a linear function between minimum and maximum intensity.
Option "Set input #4" programmed "Brake":
the mechanical brake pedal has a switch and a potentiometer installed. When the accelerator is released and the pedal brake is pushed the inverter performs an electrical braking whose intensity is proportional to the brake pedal potentiometer. The minimum intensity is established by the "Release braking" parameter, when the brake pedal is slightly pressed (brake switch closed but brake potentiometer at the minimum). The maximum intensity is established by the "Pedal braking" parameter when the brake pedal is fully pressed (brake potentiometer at the maximum). In the middle positions, the electrical braking intensity is a linear function between minimum and maximum intensity.
- DIGITAL: The truck does not have a potentiometer installed on the mechanical brake pedal, but only a microswitch; when the accelerator pedal is released and the brake pedal is pushed (brake switch closed), the inverter performs an electrical braking following "Pedal braking" parameter.
- NONE: Means that there aren't any switch or potentiometer installed on the brake.

10 QUICK INVERSION

- NONE The quick inversion function is not managed.
- TIMED The quick inversion function is timed.
- BELLY The quick inversion function is managed but not timed.

11 AUX VOLTAGE #1

- % this parameter permits to program the supply voltage of the main contactor coil and the electromechanical brake.

12 PERFORMANCE

- OPTION #1 Set of parameter which determines a "Low Performance".
- OPTION #2 Set of parameter which determines a "High Performance".

13 VALVE 1 TYPE

- OPTION #1 Electrovalve n°1 is an On/Off valve.
- OPTION #2 Electrovalve n°1 is a proportional valve.

14 VALVE 2 TYPE

- OPTION #1 Electrovalve n°2 is an On/Off valve.
- OPTION #2 Electrovalve n°2 is a proportional valve.

SOTTOMENU' "ADJUSTMENT"

- 1 MIN LIFT: records the minimum value of the lifting proportional potentiometer when the "Lift" switch is closed;
- 2 MAX LIFT: records the maximum value of the lifting proportional potentiometer.
- 3 MIN LOWER: records the minimum value of the lowering proportional potentiometer when the "Lower" switch is closed;
- 4 MAX LOWER: records the maximum value of the lowering proportional potentiometer.
- 3 SET BATTERY TYPE: selects the nominal battery voltage;
- 4 ADJUST BATTERY: fine adjustment of the battery voltage measured by the controller.
- 5 THROTTLE 0 ZONE: establishes a deadband in the accelerator input curve (see also curve below).
- 6 THROTTLE X POINT: These parameter change the characteristic of the accelerator input curve.

7 THROTTLE Y POINT: These parameter change the characteristic of the accelerator input curve.

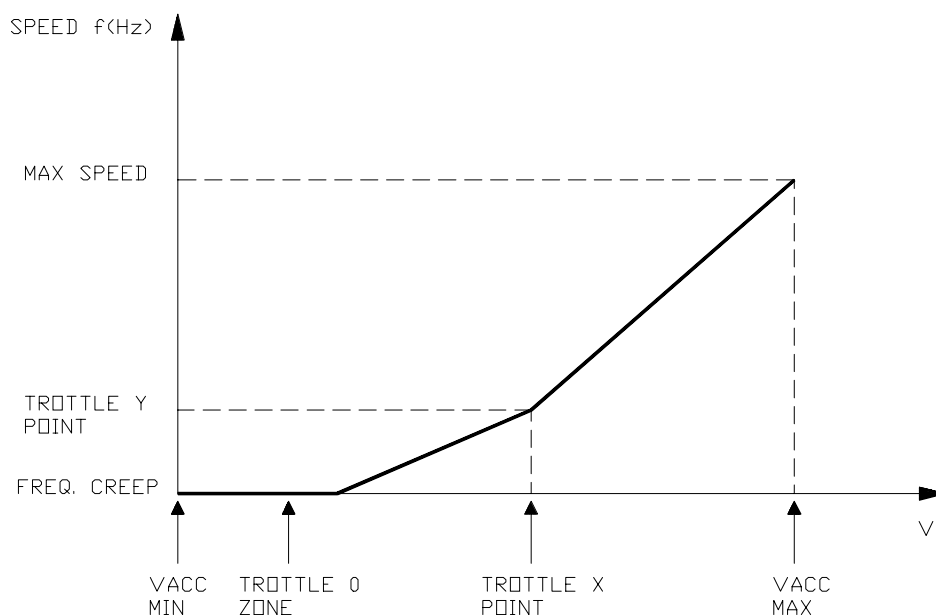

VACC MIN and VACC MAX are values programmable by the "Program Vacc" function.

8 ADJUSTMENT #01: adjust the upper level of the battery discharge table.

9 ADJUSTMENT #02: adjust the lower level of the battery discharge table.

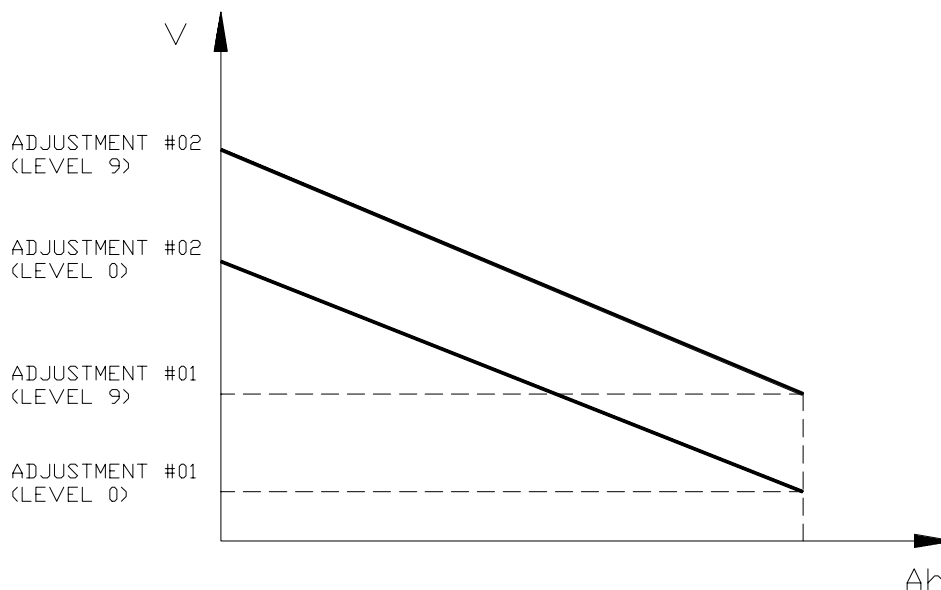

11 CHECK UP DONE: for an explanation of this point see the MDI instrument handbook

12 CHECK UP TYPE: for an explanation of this point see the MDI instrument handbook

AUX OUTPUT	STOP ON RAMP	A3 OUTPUT	BEHAVIOUR ON A SLOPE
BRAKE	ON	-Drives the coil of a electromagnetic brake.	The truck is electrically hold on a slope; when the time set by "auxiliary time" parameter is elapsed the brake is applied and the 3-phase bridge is released. <u>Do not use this combination if the negative brake is not installed.</u>
BRAKE	OFF	-Drives the coil of a electromagnetic brake.	The truck is not electrically hold on a slope, but comes down very slowly; when the time set by "auxiliary time" parameter is elapsed, the brake is applied and the 3-phase bridge is opened. <u>Do not use this combination if the negative brake is not installed.</u>
HYDRO CONT.	ON	-Drives the coil of a hydraulic steering contactor.	The truck is electrically hold on a slope; when the time set by "auxiliary time" parameter is elapsed, the truck comes down very slowly, till the flat is reached.
HYDRO CONT.	OFF	-Drives the coil of a hydraulic steering contactor.	The truck is not electrically hold on a slope, but comes down very slowly till the flat is reached.
EXCL. HYDRO	ON	-Drives the coil of a hydraulic steering contactor.	The truck is electrically hold on a slope; when the time set by "auxiliary time" parameter is elapsed, the truck comes down very slowly, till the flat is reached.
EXCL. HYDRO	OFF	-Drives the coil of a hydraulic steering contactor.	The truck is not electrically hold on a slope, but comes down very slowly till the flat is reached.

Flow chart showing how to make changes to OPTION Menu.

- 1) Opening Zapi Menu
- 2) Press Top Left & Right Buttons to enter SET Menu.
- 3) The Display will show: SET MODEL
- 4) Press ROLL UP or ROLL DOWN button until SET MODEL Menu appears.
- 5) SET OPTIONS appears on the display.
- 6) Press ENTER to go into the SET MODEL Menu.
- 7) The display will shows the first OPTION.
- 8) Press ROLL UP or ROLL DOWN button until desired OPTION appears
- 9) Desired OPTION appears.
- 10) Press SET UP or SET DOWN button in order to modify the changes.
- 11) New OPTION appears.
- 12) Press OUT to exit the Menu.
- 13) Confirmation request appears.
- 14) Press ENTER to accept the changes, or press OUT if you do not accept the changes.
- 15) SET OPTIONS Menu appears.
- 16) Press OUT again. Display now show the Opening Zapi Menu.

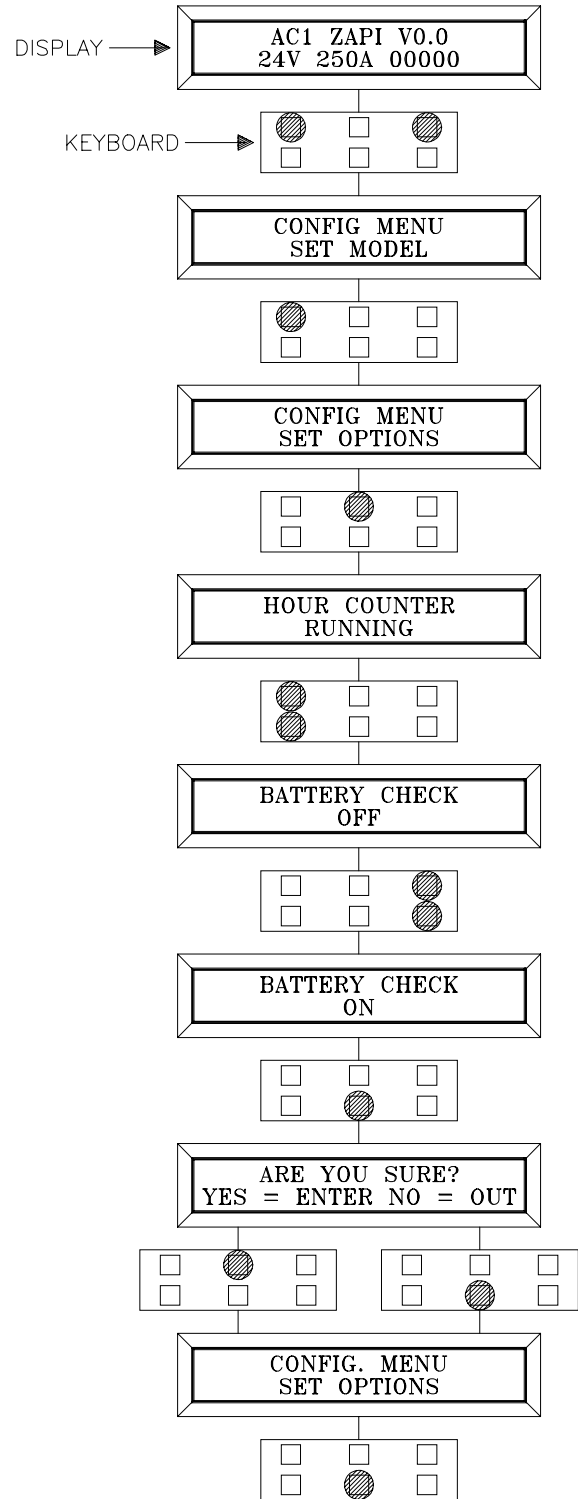

Flow chart showing how to make changes to ADJUSTMENT Menu

- 1) Opening Zapi Menu
- 2) Press Top Left & Right Buttons to enter CONFIG Menu.
- 3) The display will show: SET MODEL
- 4) Press ROLL UP or ROLL DOWN button until ADJUSTMENTS Menu appears.
- 5) ADJUSTMENTS appears on the display.
- 6) Press ENTER to go into the ADJUSTMENTS Menu.
- 7) The display will shows SET BATTERY TYPE.
- 8) Press ROLL UP or ROLL DOWN button until the desired parameter is reached.
- 9) The desired parameter is appears.
- 10) Press SET UP or SET DOWN button to modify the adjustment.
- 11) Press OUT.
- 12) Press ENTER to confirm.
- 13) Repeat the same from 5 to 12 points for the other adjustment.

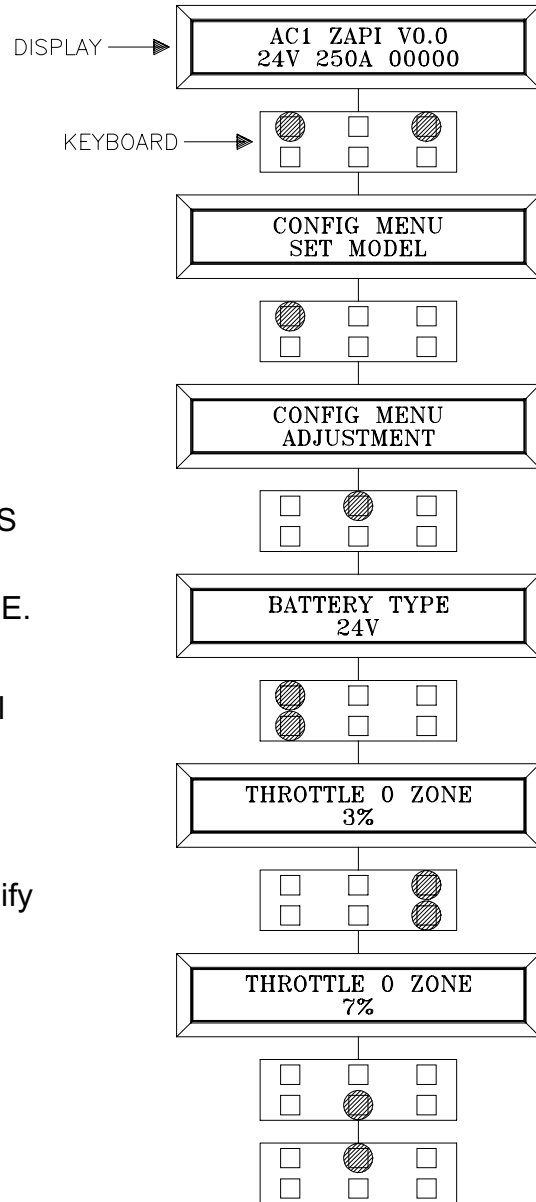

Flow chart showing how to use the SET BATTERY TYPE adjustment

- 1) Opening Zapi Menu
- 2) Press Top Left & Right Buttons to enter CONFIG Menu.
- 3) The Display will show: SET MODEL
- 4) Press ROLL UP button until ADJUSTMENTS. menu appears.
- 5) ADJUSTMENTS appears on the display.
- 6) Press ENTER to go into the ADJUSTMENTS Menu.
- 7) The display will show: SET BATTERY TYPE.
- 8) Press SET UP to choose nominal value of the battery.
- 9) New battery value appears.
- 10) Press OUT.
- 11) Confirmation request appears.
- 12) Press ENTER to accept the changes, or press OUT if you do not accept the changes.
- 13) Press OUT. Display now shows the Opening Zapi Menu.

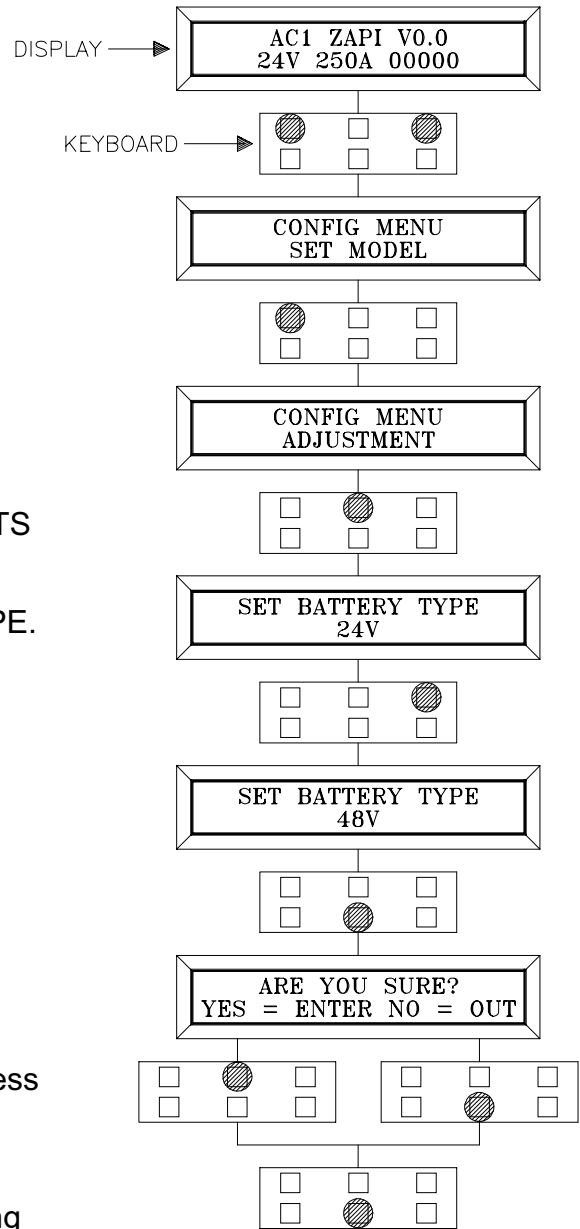

Flow chart showing how to carry out ADJUSTMENT BATTERY operation by console.

- 1) Opening Zapi Menu
- 2) Press Top Left & Right Buttons to enter CONFIG Menu.
- 3) The Display will show: SET MODEL
- 4) Press ROLL UP button until ADJUSTMENT Menu appears.
- 5) ADJUSTMENTS appears on the display.
- 6) Press ENTER to go into the ADJUSTMENTS Menu.
- 7) The display will show the first OPTION.
- 8) Press ROLL UP or ROLL DOWN button until desired OPTION appears
- 9) ADJUST BATTERY appears.
- 10) Press SET UP or SET DOWN button in order to increase or decrease respectively. Set the value read by an external meter.
- 11) Battery value appears on the display.
- 12) Press OUT to exit the Menu.
- 13) Confirmation request appears.
- 14) Press ENTER to accept the changes, or press OUT if you do not accept the changes.
- 15) ADJUSTMENTS Menu appears.
- 16) Press OUT. Display now show the Opening Zapi Menu.

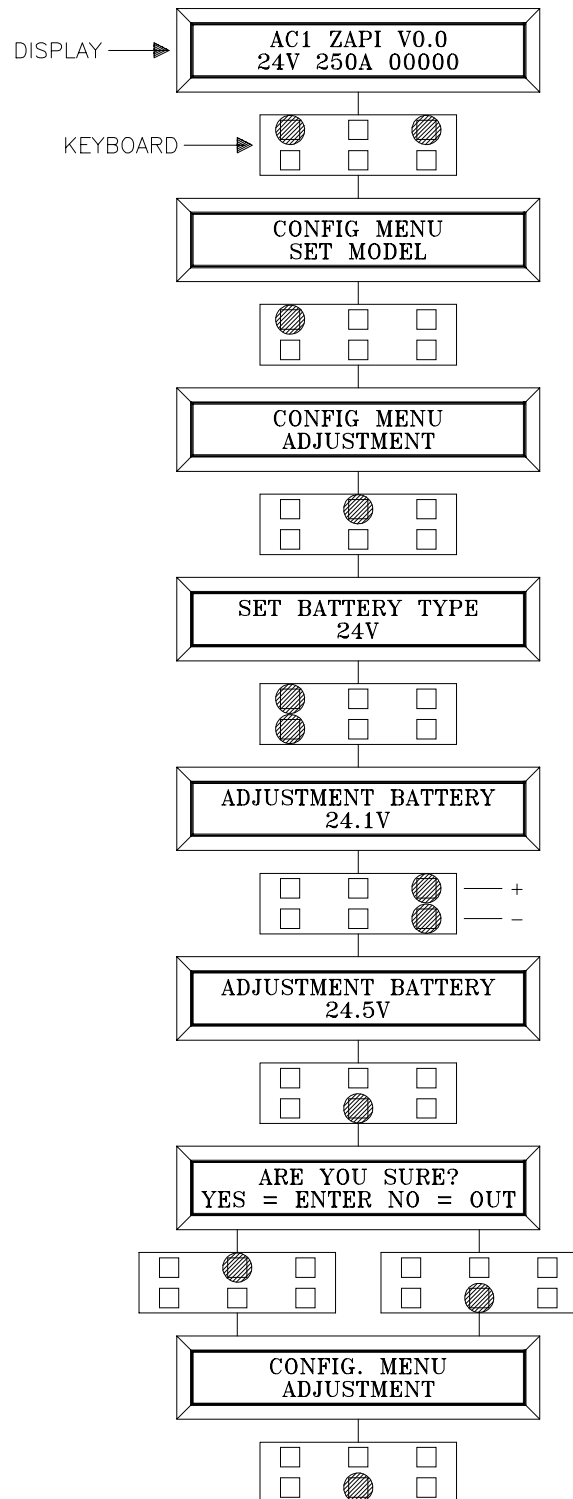

4.5 PARAMETER REGULATION: STANDARD VERSION

The following parameters can be modified:

- | | | |
|----|----------------------|--|
| 1 | ACC DELAY: | determines the acceleration ramp. |
| 2 | RELEASE BRAKING: | controls the deceleration ramp when the travel request is released. |
| 3 | INVERSION BRAKING: | controls the deceleration ramp when the direction switch is inverted during travel.. |
| 4 | PEDAL BRAKING: | determines the deceleration ramp when the travel request is released and the brake pedal switch is closed. |
| 5 | SPEED LIMIT BRAKING: | deceleration ramp when the pedal position is changed but not completely released. |
| 6 | BRAKE CUTBACK: | determines the deceleration ramp when the speed reduction input becomes active and the motor slow down. |
| 7 | MAX SPEED FORWARD: | determines the maximum speed in forward direction. |
| 8 | MAX SPEED BACKWARD: | determines the maximum speed in backward direction. |
| 9 | CUTBACK SPEED 1: | speed reduction when the cutback switch 1 is active. |
| 10 | CUTBACK SPEED 2: | speed reduction when the cutback switch 2 is active. |
| 11 | CUTBACK SPEED 3: | speed reduction when the cutback switch 3 is active. |
| 12 | H&S CUTBACK: | speed reduction when the Hard&Soft switch is active. |
| 13 | FREQUENCY CREEP: | minimum speed when the forward or reverse switch is closed, but the accelerator is on a minimum position. |
| 14 | MAXIMUM CURRENT: | this changes the maximum current of the inverter. |
| 15 | BACKING SPEED: | determines the speed in inching function. |
| 16 | BACKING TIME: | determines the time of the inching function. |
| 17 | AUXILIARY TIME: | determines the time that the truck is hold on the ramp if the "stop on ramp" option is ON. |

The following table shows the different values at which the parameters can be set.

PARAMETER	UNIT	PROGRAMMED LEVEL									
		0	1	2	3	4	5	6	7	8	9
ACCELERATION DELAY (*)	Sec.	2.5	3.0	3.5	4.0	4.5	5.0	5.5	6.0	6.5	7.0
RELEASE BRAKING (**)	Sec.	5.5	5.0	4.5	4.0	3.5	3.0	2.5	2.0	1.5	1.0
INVERS BRAKING (**)	Sec.	5.5	5.0	4.5	4.0	3.5	3.0	2.5	2.0	1.5	1.0
PEDAL BRAKING (**)	Sec.	5.5	5.0	4.5	4.0	3.5	3.0	2.5	2.0	1.5	1.0
SPEED LIMIT BRAKING (**)	Sec.	8.9	8.3	7.7	7.1	6.6	6.0	5.5	4.9	4.4	3.8
BRAKE CUTBACK (**)	Sec.	5.5	5.0	4.5	4.0	3.5	3.0	2.5	2.0	1.5	1.0
MAX SPEED FW	Hz	65	80	95	110	125	140	155	170	185	200
MAX SPEED BW	Hz	65	80	95	110	125	140	155	170	185	200
CUTBACK SPEED 1	%Max Sp	10	15	20	25	37	50	62	75	87	100
CUTBACK SPEED 2	%Max Sp	10	15	20	25	37	50	62	75	87	100
CUTBACK SPEED 3	%Max Sp	10	15	20	25	37	50	62	75	87	100
H&S CUTBACK	%Max Sp	10	15	20	25	37	50	62	75	87	100
FREQUENCY CREEP	Hz	0.3	0.6	0.9	1.2	1.5	1.8	2.1	2.4	2.7	3.0
MAXIMUM CURRENT	% IMAX	47	53	58	64	70	76	82	88	94	100
BACKING SPEED	Hz	0	2	4	6	8	10	12	14	16	18
BACKING TIME	Sec.	0.2	0.5	1.0	1.4	1.8	2.3	2.7	3.1	3.6	4.0
AUXILIARY TIME	Sec.	0	0.4	0.8	1.6	2.0	3.0	4.0	6.0	8.0	10.0

- (*) The acceleration time shown is the time from 0 Hz to 100 Hz. This is the ideal ramp calculated by the software; the real ramp could change as a function of motor control parameter setting and, obviously, as a function of the load.
- (**) The braking feature is based upon deceleration ramps. The value shown in the table is the time to decrease the speed from 100 Hz to 0 Hz. This is the ideal ramps calculated by the software; the real ramp could change as a function of motor control parameter setting and, obviously, as a function of the load.

4.6 PARAMETER REGULATION: MDI PRC VERSION

The following parameters can be modified:

- | | | |
|----|----------------------|--|
| 1 | ACC DELAY: | determines the acceleration ramp. |
| 2 | RELEASE BRAKING: | controls the deceleration ramp when the travel request is released. |
| 3 | INVERSION BRAKING: | controls the deceleration ramp when the direction switch is inverted during travel.. |
| 4 | PEDAL BRAKING: | determines the deceleration ramp when the travel request is released and the brake pedal switch is closed. |
| 5 | SPEED LIMIT BRAKING: | deceleration ramp when the pedal position is changed but not completely released. |
| 6 | BRAKE CUTBACK: | determines the deceleration ramp when the speed reduction input becomes active and the motor slow down. |
| 7 | MAX SPEED FORWARD: | determines the maximum speed in forward direction. |
| 8 | MAX SPEED BACKWARD: | determines the maximum speed in backward direction. |
| 9 | CUTBACK SPEED 1: | speed reduction when the cutback switch 1 is active. |
| 10 | H&S CUTBACK: | speed reduction when the Hard&Soft switch is active. |
| 11 | FREQUENCY CREEP: | minimum speed when the forward or reverse switch is closed, but the accelerator is on a minimum position. |
| 12 | MAXIMUM CURRENT: | this changes the maximum current of the inverter. |
| 13 | BACKING SPEED: | determines the speed when the "Backing function" is active. |
| 14 | BACKING TIME: | determines the during time when the "Backing function" is active. |
| 15 | AUXILIARY TIME: | determines the time that the truck is hold on a slope (only if the "Stop on ramp" option is ON). |
| 16 | MIN VALVE 1: | this parameter determines the minimum voltage applied on the electrovalve 1 when the position of the potentiometer is at the minimum. This parameter is not effective if the electrovalve 1 is programmed like a On/Off valve (see the configuration chapter). |
| 17 | MIN VALVE 2: | this parameter determines the minimum voltage applied on the electrovalve 2 when the position of the potentiometer is at the minimum. This parameter is not effective if the electrovalve 2 is programmed like a On/Off valve (see the configuration chapter). |

- 18 MAX VALVE 1: this parameter determines the maximum voltage applied on the electrovalve 1 when the position of the potentiometer is at the maximum. If the electrovalve 1 is programmed like a On/Off valve (see the configuration chapter) this parameter determines the voltage applied on the electrovalve coil.
- 19 MAX VALVE 2: this parameter determines the maximum voltage applied on the electrovalve 2 when the position of the potentiometer is at the maximum. If the electrovalve 2 is programmed like a On/Off valve (see the configuration chapter) this parameter determines the voltage applied on the electrovalve coil.
- 20 VALVE 3 VOLTAGE: this parameter determines the voltage applied on the electrovalve 3.
- 21 VALVE 4 VOLTAGE: this parameter determines the voltage applied on the electrovalve 4.
- 22 V1 OPENING RAMP this parameter determines the ramp of voltage applied on the electrovalve 1 in the opening transition (if proportional); this is the time necessary to go from the minimum to the maximum voltage. If the electrovalve is programmed like an On/Off valve this parameter is not effective.
- 23 V2 OPENING RAMP this parameter determines the ramp of voltage applied on the electrovalve 2 in the opening transition. (if proportional); this is the time necessary to go from the minimum to the maximum voltage. If the electrovalve is programmed like an On/Off valve this parameter is not effective.
- 24 V1 CLOSING RAMP this parameter determines the ramp of voltage applied on the electrovalve 1 in the closing transition (if proportional); this is the time necessary to go from the maximum to the minimum voltage. If the electrovalve is programmed like an On/Off valve this parameter is not effective.
- 25 V2 CLOSING RAMP this parameter determines the ramp of voltage applied on the electrovalve 2 in the closing transition (if proportional); this is the time necessary to go from the maximum to the minimum voltage. If the electrovalve is programmed like an On/Off valve this parameter is not effective.

The following table shows the different values at which the parameters can be set.

PARAMETER	UNIT	PROGRAMMED LEVEL									
		0	1	2	3	4	5	6	7	8	9
ACCELERATION DELAY (*)	Sec.	2.5	3.0	3.5	4.0	4.5	5.0	5.5	6.0	6.5	7.0
RELEASE BRAKING (**)	Sec.	5.5	5.0	4.5	4.0	3.5	3.0	2.5	2.0	1.5	1.0
INVERS BRAKING (**)	Sec.	5.5	5.0	4.5	4.0	3.5	3.0	2.5	2.0	1.5	1.0
PEDAL BRAKING (**)	Sec.	5.5	5.0	4.5	4.0	3.5	3.0	2.5	2.0	1.5	1.0
SPEED LIMIT BRAKING (**)	Sec.	8.9	8.3	7.7	7.1	6.6	6.0	5.5	4.9	4.4	3.8
BRAKE CUTBACK (**)	Sec.	5.5	5.0	4.5	4.0	3.5	3.0	2.5	2.0	1.5	1.0
MAX SPEED FW	Hz	65	80	95	110	125	140	155	170	185	200
MAX SPEED BW	Hz	65	80	95	110	125	140	155	170	185	200
CUTBACK SPEED 1	%Max Sp	10	15	20	25	37	50	62	75	87	100
H&S CUTBACK	%Max Sp	10	15	20	25	37	50	62	75	87	100
FREQUENCY CREEP	Hz	0.3	0.6	0.9	1.2	1.5	1.8	2.1	2.4	2.7	3.0
MAXIMUM CURRENT	% I _{MAX}	47	53	58	64	70	76	82	88	94	100
BACKING SPEED	Hz	0	2	4	6	8	10	12	14	16	18
BACKING TIME	Sec.	0.2	0.5	1.0	1.4	1.8	2.3	2.7	3.1	3.6	4.0
AUXILIARY TIME	Sec.	0	0.4	0.8	1.6	2.0	3.0	4.0	6.0	8.0	10.0
MIN VALVE 1	This parameter can be adjusted from 1 to 255 with regulation of 1digit										
MIN VALVE 2	This parameter can be adjusted from 1 to 255 with regulation of 1digit										
MAX VALVE 1	This parameter can be adjusted from 1 to 255 with regulation of 1digit										
MAX VALVE 2	This parameter can be adjusted from 1 to 255 with regulation of 1digit										
VALVE 3 VOLTAGE	% V	10	20	30	40	50	60	70	80	90	100
VALVE 4 VOLTAGE	% V	10	20	30	40	50	60	70	80	90	100
V1 OPENING RAMP	Sec.	0.2	0.4	0.6	0.8	1.0	1.2	1.4	1.6	1.8	2.0
V2 OPENING RAMP	Sec.	0.2	0.4	0.6	0.8	1.0	1.2	1.4	1.6	1.8	2.0
V1 CLOSING RAMP	Sec.	0.2	0.4	0.6	0.8	1.0	1.2	1.4	1.6	1.8	2.0
V2 CLOSING RAMP	Sec.	0.2	0.4	0.6	0.8	1.0	1.2	1.4	1.6	1.8	2.0

(*) The acceleration time shown is the time from 0 Hz to 100 Hz. This is the ideal ramp calculated by the software; the real ramp could change as a function of motor control parameter setting and, obviously, as a function of the load.

(**) The braking feature is based upon deceleration ramps. The value shown in the table is the time to decrease the speed from 100 Hz to 0 Hz. This is the ideal ramps calculated by the software; the real ramp could change as a function of motor control parameter setting and, obviously, as a function of the load.

- 1) Opening Zapi Display.
- 2) Press ENTER to go into the General Menu.
- 3) The Display will show :
- 4) Press ENTER to go into the Parameter Change facility.
- 5) The Display will show the first parameter.
- 6) Press either ROLL UP and ROLL DOWN to display the next parameter.
- 7) The names of the Parameters appear on the Display.
- 8) When the desired Parameter appears, the Display will show a Level Number that will be between 0 and 9. Press either PARAM (Top Right) or SET (Bottom Right) buttons to change the Level value.
- 9) The Display will show the New Level.
- 10) When you are satisfied with the results of the changes you have made, Press OUT.
- 11) The Display asks " ARE YOU SURE"?
- 12) Press ENTER to accept the changes, or press OUT if you do not wish to accept the changes and wish to make further modifications to the parameters.
- 13) The Display will show :

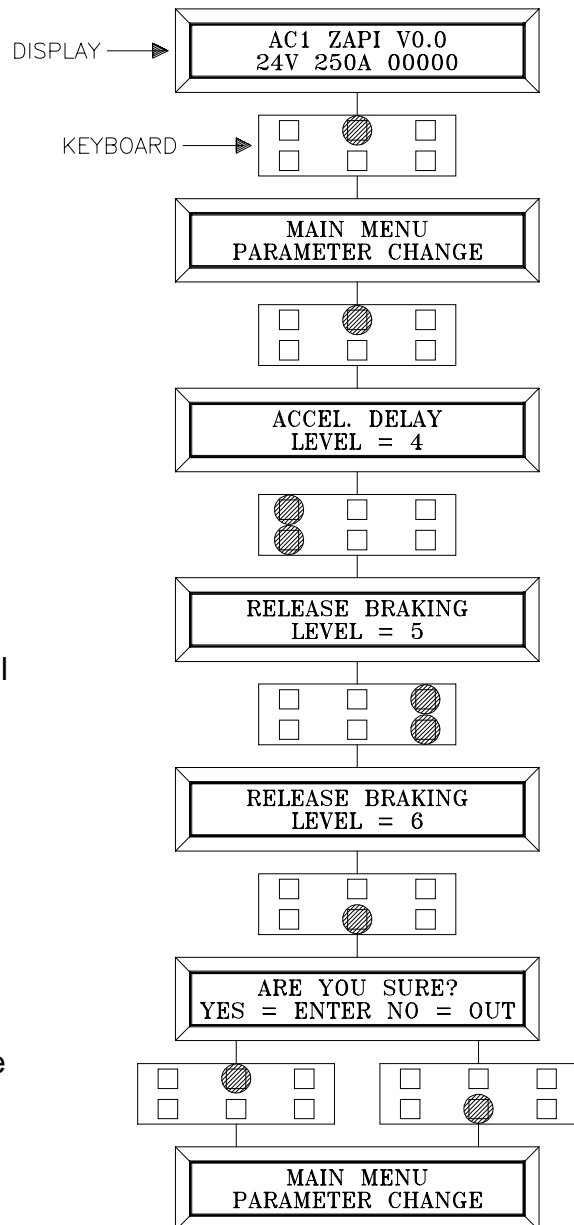

4.7 PROGRAMMING CONSOLE FUNCTIONS

- Functional configuration (see 4.1 , 4.2 , 4.3 , 4.4)

- Parameter programming (see 4.5 , 4.6)

- Tester: the user can verify the state of the following parameters:

STANDARD Version	MDI PRC Version
battery voltage (V)	battery voltage (V)
motor voltage (%)	motor voltage (%)
voltage booster (%)	voltage booster (%)
frequency (Hz)	frequency (Hz)
encoder (Hz)	encoder (Hz)
slip value (Hz)	slip value (Hz)
cos fi	cos fi
current rms (A)	current rms (A)
battery current (A)	battery current (A)
battery charge (A)	battery charge (A)
temperature (°C)	temperature (°C)
accelerator (V)	accelerator (V)
brake pedal pot (%)	lifting control (V)
lifting switch (ON/OFF)	lifting switch (ON/OFF)
descent switch (ON/OFF)	descent switch (ON/OFF)
forward switch (ON/OFF)	forward switch (ON/OFF)
backward switch (ON/OFF)	backward switch (ON/OFF)
seat switch (ON/OFF)	seat switch (ON/OFF)
Hard&Soft (ON/OFF)	Hard&Soft (ON/OFF)
quick inversion(ON/OFF)	quick inversion(ON/OFF)
cutback switch (ON/OFF)	cutback switch (ON/OFF)
cutback switch 2 (ON/OFF)	digital input #1 (ON/OFF)
cutback switch 3 (ON/OFF)	digital input #2 (ON/OFF)

- Save function (for storing data)

- Restore function (for loading parameters on another chopper)

- Display of the last 5 alarms including hour-meter value and temperature at the moment of the alarm.

- Accelerator range programming: records the minimum and maximum useful accelerator stroke values for both direction of running.

- See the console manual for a detailed description of function and parameters.

4.8 SEQUENCE FOR AC INVERTER TRACTION SETTING

When the "Key Switch" is closed, if no alarms or errors are present, the Console Display will be showing the Standard Zapi Opening Display.

If the chopper is not configured to your requirements, follow the sequence detailed on Chapter 5.2 . Remember to re-cycle the Key Switch if you make any changes to the chopper's configuration. Otherwise follow the sequence detailed below :

- 1) Select the Options required. See Chapter 4.1 ÷ 4.4.
- 2) Select and set the Battery Voltage. See Chapter 4.4.
- 3) Confirm correct installation of all wires. Use the Console's TESTER function to assist.
- 4) Perform the accelerator signal acquisition procedure using the Console "PROGRAM VACC". Procedure is detailed on Chapter 5.4.
- 5) Set the "MAXIMUM CURRENT" Current, using the table on Chapter 4.5 , 4.6.
- 6) Set the Acceleration Delay requirements for the machine. Test the parameters in both directions.
- 7) Set the FREQUENCY CREEP level starting from level 0.6 Hz. The machine should just move when the accelerator microswitch is closed. Increase the Level accordingly.
- 8) Set the Speed Reductions as required. Make adjustments to "CUTBACK SPEED" Check the performance with the accelerator pedal totally depressed. If the machine is a forklift, check the performance with and without load.
- 9) RELEASE BRAKING. Operate the machine at full speed. Release the accelerator pedal. Adjust the level to your requirements. If the machine is a forklift, check the performance with and without load.
- 10) INVERSION BRAKING. Operate the machine at 25% full speed. Whilst traveling INVERT the Direction Switch. Set a soft Level of Inversion Braking. When satisfactory, operate the machine at Full Speed and repeat. If the machine is a Forklift, repeat the tests and make adjustments with and without load. The unladen full speed condition should be the most representative condition.
- 11) PEDAL BRAKING (If used). Operate the machine at full Speed. Release the accelerator pedal and press the Pedal Brake. Set braking level to your requirements.
- 12) Set "MAX SPEED FORW".
- 13) Set "MAX SPEED BACK" (Reverse).
- 14) Make the choice for the truck behaviour on a slope (see chapter 4.4). If the "Stop on ramp" option is ON, set the desired value of "auxiliary time" parameter.

4.9 TESTER: DESCRIPTION OF THE FUNCTION; STANDARD VERSION

The most important input or output signals can be measured in real time using the TESTER function of the console. The Console acts as a multimeter able to read voltage, current and temperature. The following definition listing shows the relative measurements :

- 1) **BATTERY VOLTAGE:** level of battery voltage measured at the input to the key switch.
- 2) **MOTOR VOLTAGE:** this is the voltage supplied to the motor by the inverter; it is expressed as a percentage of the full voltage (which depends of the battery voltage).
- 3) **VOLTAGE BOOSTER:** this is the booster of the voltage supplied to the motor in load condition; it is expressed in a percentage of the full voltage.
- 4) **FREQUENCY:** this is the frequency of the voltage and current supplied to the motor.
- 5) **ENCODER:** this is the speed of the motor, expressed in the same unit of the frequency; this information comes from the speed sensor.
- 6) **SLIP VALUE:** this is the difference of speed between the rotating field and the shaft of the motor, expressed in the same unit of the frequency.
- 7) **COS FI:** this is the $\cos \phi$ (real time calculated) of the motor.
- 8) **CURRENT RMS:** Root Mean Square value of the motor current.
- 9) **BATTERY CURRENT:** this is the battery current (not measured but calculated).
- 10) **BATTERY CHARGE:** the percentage Charge level of the battery.
- 11) **TEMPERATURE:** the temperature measured on the aluminum heat sink holding the MOSFET devices.
- 12) **ACCELERATOR:** the voltage of the accelerator potentiometer's wiper (CPOT). The voltage level is shown on the Left Hand Side of the Console Display and the value in percentage is shown on the Right Hand Side.
- 13) **BRAKE PEDAL POT:** the voltage of the brake pedal potentiometer's wiper (CPOTB). The voltage level is shown on the Left Hand Side of the Console Display and the value in percentage is shown on the Right Hand Side.
- 14) **LIFTING SWITCH:** the level of the "Lifting switch" digital entry.
ON / +VB = active entry of closed switch.
OFF / GND = non active entry of open switch.
- 15) **DESCENT SWITCH:** the level of the "Descent switch" digital entry.
ON / +VB = active entry of closed switch.
OFF / GND = non active entry of open switch.
- 16) **FORWARD SWITCH:** the level of the Forward direction digital entry FW.
ON / +VB = active entry of closed switch.
OFF / GND = non active entry of open switch.
- 17) **BACKWARD SWITCH:** the level of the Reverse direction digital entry BW.
ON / +VB = active entry of closed switch.
OFF / GND = non active entry of open switch.

18) SEAT SWITCH: the level of the Seat Microswitch digital entry.

ON / +VB = active entry of closed switch.

OFF / GND = non active entry of open switch.

or:

TILLER SWITCH: the level of the Tiller Microswitch digital entry. ("Tiller switch" option set as "Handle").

ON / +VB = active entry of closed switch.

OFF / GND = non active entry of open switch.

19) H&S CUTBACK: the level of the Hard&Soft Microswitch digital entry.

ON / +VB = active entry of closed switch.

OFF / GND = non active entry of open switch.

20) QUICK INVERSION: the level of the Quick Inversion Microswitch digital entry. ("Set Input #4" option set as "Belly").

ON / +VB = active entry of closed switch.

OFF / GND = non active entry of open switch.

or:

BRAKE SWITCH: the level of the Brake Pedal Microswitch digital entry. ("Set Input #4" option set as "Brake").

ON / +VB = active entry of closed switch.

OFF / GND = non active entry of open switch.

or:

EXCLUSIVE HYDRO: the level of the Exclusive Hydro Microswitch digital entry. ("Set Input #4" option set as "Ex.Hydro").

ON / +VB = active entry of closed switch.

OFF / GND = non active entry of open switch.

21) CUTBACK SWITCH 1: the level of the Speed Reduction Microswitch 1. ("Set Input #1" option set as "Present").

ON / GND = active entry of open switch.

OFF / +VB = non active entry of closed switch.

or:

HAND BRAKE: the level of the Hand Brake. ("Set Input #1" option set as "Option #1").

ON / GND = active entry of open switch.

OFF / +VB = non active entry of closed switch.

22) CUTBACK SWITCH 2: the level of the Speed Reduction Microswitch 2. ("Set Input #2" option set as "Present").

ON / GND = active entry of open switch.

OFF / +VB = non active entry of closed switch.

or:

INCHING FORW: the level of the Inching Microswitch - Forward direction. ("Set Input #2" option set as "Option #1").

ON / +VB = active entry of closed switch.

OFF / GND = non active entry of open switch.

23) CUTBACK SWITCH 3: the level of the Speed Reduction Microswitch 3. ("Set Input #3" option set as "Present").

ON / GND = active entry of open switch.

OFF / +VB = non active entry of closed switch.

or:

INCHING BACK: the level of the Inching Microswitch - Backward direction. ("Set Input #3" option set as "Option #1").

ON / +VB = active entry of closed switch.

OFF / GND = non active entry of open switch.

4.10 TESTER: DESCRIPTION OF THE FUNCTION; MDI PRC VERSION

The most important input or output signals can be measured in real time using the TESTER function of the console. The Console acts as a multimeter able to read voltage, current and temperature. The following definition listing shows the relative measurements :

- 1) **BATTERY VOLTAGE:** level of battery voltage measured at the input to the key switch.
- 2) **MOTOR VOLTAGE:** this is the voltage supplied to the motor by the inverter; it is expressed as a percentage of the full voltage (which depends of the battery voltage).
- 3) **VOLTAGE BOOSTER:** this is the booster of the voltage supplied to the motor in load condition; it is expressed in a percentage of the full voltage.
- 4) **FREQUENCY:** this is the frequency of the voltage and current supplied to the motor.
- 5) **ENCODER:** this is the speed of the motor, expressed in the same unit of the frequency; this information comes from the speed sensor.
- 6) **SLIP VALUE:** this is the difference of speed between the rotating field and the shaft of the motor, expressed in the same unit of the frequency.
- 7) **COS FI:** this is the $\cos \varphi$ (real time calculated) of the motor.
- 8) **CURRENT RMS:** Root Mean Square value of the motor current.
- 9) **BATTERY CURRENT:** this is the battery current (not measured but calculated).
- 10) **BATTERY CHARGE:** the percentage Charge level of the battery.
- 11) **TEMPERATURE:** the temperature measured on the aluminum heat sink holding the MOSFET devices.
- 12) **ACCELERATOR:** the voltage of the accelerator potentiometer's wiper (CPOT). The voltage level is shown on the Left Hand Side of the Console Display and the value in percentage is shown on the Right Hand Side.
- 13) **LIFTING CONTROL:** the voltage of the lifting potentiometer's wiper (CPOTB). The voltage level is shown on the Left Hand Side of the Console Display and the value in percentage is shown on the Right Hand Side.
- 14) **LIFTING SWITCH:** the level of the "Lifting switch" digital entry.
ON / +VB = active entry of closed switch.
OFF / GND = non active entry of open switch.
- 15) **DESCENT SWITCH:** the level of the "Descent switch" digital entry.
ON / +VB = active entry of closed switch.
OFF / GND = non active entry of open switch.
- 16) **FORWARD SWITCH:** the level of the Forward direction digital entry FW.
ON / +VB = active entry of closed switch.
OFF / GND = non active entry of open switch.
- 17) **BACKWARD SWITCH:** the level of the Reverse direction digital entry BW.
ON / +VB = active entry of closed switch.
OFF / GND = non active entry of open switch.

18) SEAT SWITCH: the level of the Seat Microswitch digital entry.

ON / +VB = active entry of closed switch.

OFF / GND = non active entry of open switch.

or:

TILLER SWITCH: the level of the Tiller Microswitch digital entry. ("Tiller switch" option set as "Handle").

ON / +VB = active entry of closed switch.

OFF / GND = non active entry of open switch.

19) H&S CUTBACK: the level of the Hard&Soft Microswitch digital entry.

ON / +VB = active entry of closed switch.

OFF / GND = non active entry of open switch.

20) QUICK INVERSION: the level of the Quick Inversion Microswitch digital entry. ("Set Input #4" option set as "Belly").

ON / +VB = active entry of closed switch.

OFF / GND = non active entry of open switch.

or:

BRAKE SWITCH: the level of the Brake Pedal Microswitch digital entry. ("Set Input #4" option set as "Brake").

ON / +VB = active entry of closed switch.

OFF / GND = non active entry of open switch.

or:

EXCLUSIVE HYDRO: the level of the Exclusive Hydro Microswitch digital entry. ("Set Input #4" option set as "Ex.Hydro").

ON / +VB = active entry of closed switch.

OFF / GND = non active entry of open switch.

21) CUTBACK SWITCH 1: the level of the Speed Reduction Microswitch 1. ("Set Input #1" option set as "Present").

ON / GND = active entry of open switch.

OFF / +VB = non active entry of closed switch.

or:

HAND BRAKE: the level of the Hand Brake. ("Set Input #1" option set as "Option #1").

ON / GND = active entry of open switch.

OFF / +VB = non active entry of closed switch.

22) DIGITAL INPUT #1: the level of the Auxiliary Lifting digital entry.

ON / +VB = active entry of closed switch.

OFF / GND = non active entry of open switch.

23) DIGITAL INPUT #2: the level of the Auxiliary Lowering digital entry.

ON / +VB = active entry of closed switch.

OFF / GND = non active entry of open switch.

Flow Chart showing how to use the TESTER function of the Digital Console.

1) Opening Zapi Display.

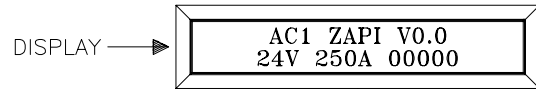

2) Press ENTER to go into the General menu.

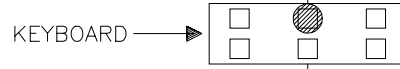

3) The Display will show :

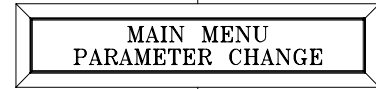

4) Press ROLL UP or ROLL DOWN button until TESTER MENU appear on the display.

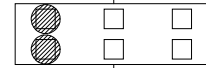

5) The Display shows :

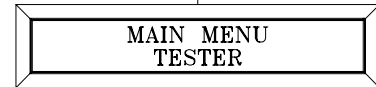

6) Press ENTER to go into the TESTER function.

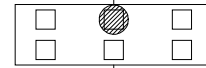

7) The first variable to be tested is shown on the Display.

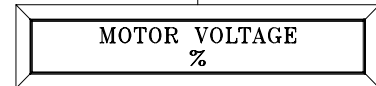

8) Press either ROLL UP or ROLL DOWN buttons until your desired variable for measurement appears on the Display.

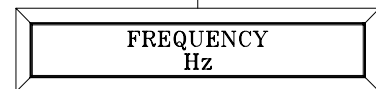
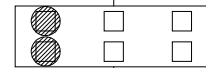

9) When you have finished, Press OUT.

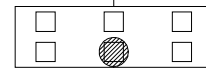

10) The Display shows :

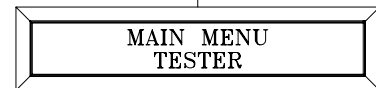

11) Press OUT again and return to Opening Zapi Display.

Remember it is not possible to make any changes using TESTER. All you can do is measure as if you were using a pre-connected multimeter.

5 OTHER FUNCTIONS

5.1 DESCRIPTION OF THE CONSOLE SAVE FUNCTION

The SAVE function allows the operator to transmit the Parameter values and Configuration data of the chopper into the Console memory. It is possible to load 64 different programmes.

The information saved in the Console memory can then be reloaded into another chopper using the RESTORE function.

The data that is available via the SAVE function is as follows:

- All Parameter Values (PARAMETER CHANGE).
- Options (SET. OPTIONS).
- The Level of the Battery (ADJUST BATTERY).

Flow Chart showing how to use the SAVE function of the Digital Console.

1) Opening Zapi Display.

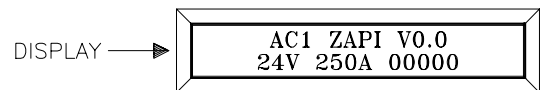

2) Press ENTER to go into the General menu.

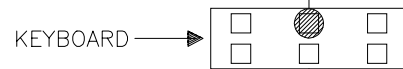

3) The Display will show :

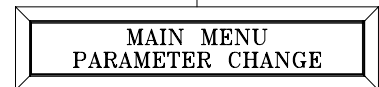

4) Press ROLL UP or ROLL DOWN button until SAVE PARAM. appears on the display

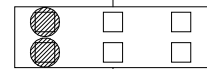

5) The Display will show :

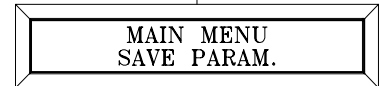

6) Press ENTER to go into the SAVE function.

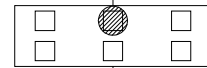

7) If this facility has been used before the type of chopper data stored appears on the top Main with a 2 digit reference.

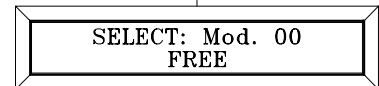

8) Keep pressing either ROLL UP or ROLL DOWN keys until the second Main indicates a FREE storage facility.

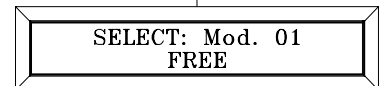
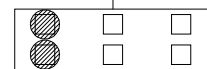

9) Press ENTER to commence SAVE routine.

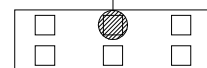

10) You can see the items that are being stored whilst the SAVE routine is happening.

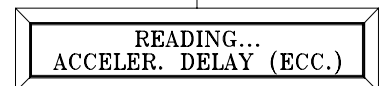

11) When finished, the Console shows :



13) Press OUT to return to the Opening Zapi Display.

5.2 DESCRIPTION OF CONSOLE RESTORE FUNCTION.

The RESTORE PARAM function allows transfer of the Console's stored data into the memory of the chopper. This is achieved in a fast and easy way using the method previously used with the SAVE PARAM. function.

The data that is available via the RESTORE PARAM. function is as follows :

- All Parameter Values (PARAMETER CHANGE).
- Options (SET OPTIONS)
- The level of the Battery (ADJUST BATTERY)

ATTENTION: When the RESTORE operation is made, all data in the chopper memory will be written over and replaced with data being restored.

Flow Chart showing how to use the RESTORE function of the Digital Console.

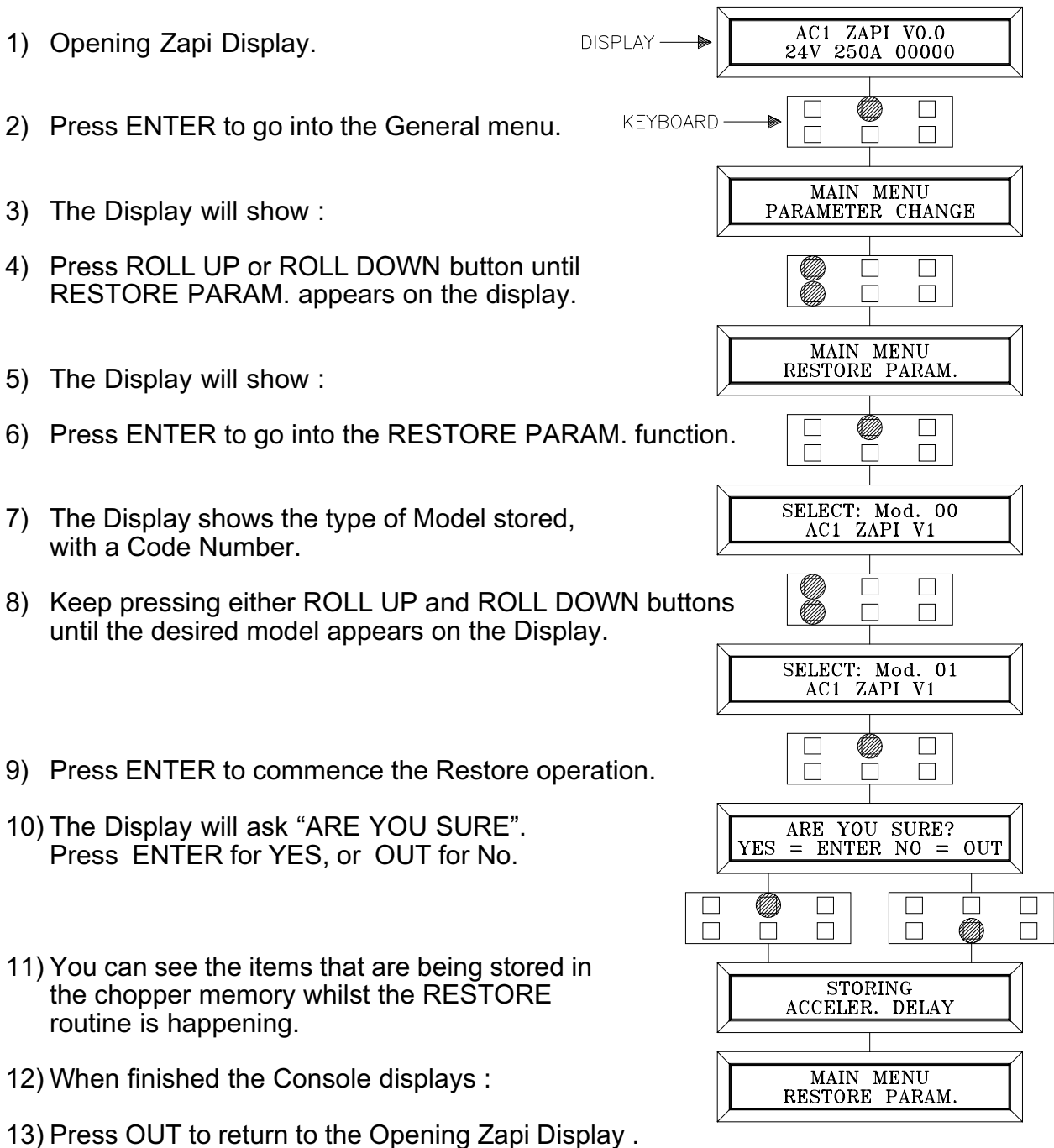

5.3 DESCRIPTION OF ALARMS MENU

The microprocessor in the chopper remembers the last five Alarms that have occurred. Items remembered relative to each Alarm are : the code of the alarm, the number of times the particular Alarm occurred, the Hour Meter count, and the chopper temperature. This function permits a deeper diagnosis of problems as the recent history can now be accessed.

Flow Chart showing how to use the ALARMS function via the Digital Console.

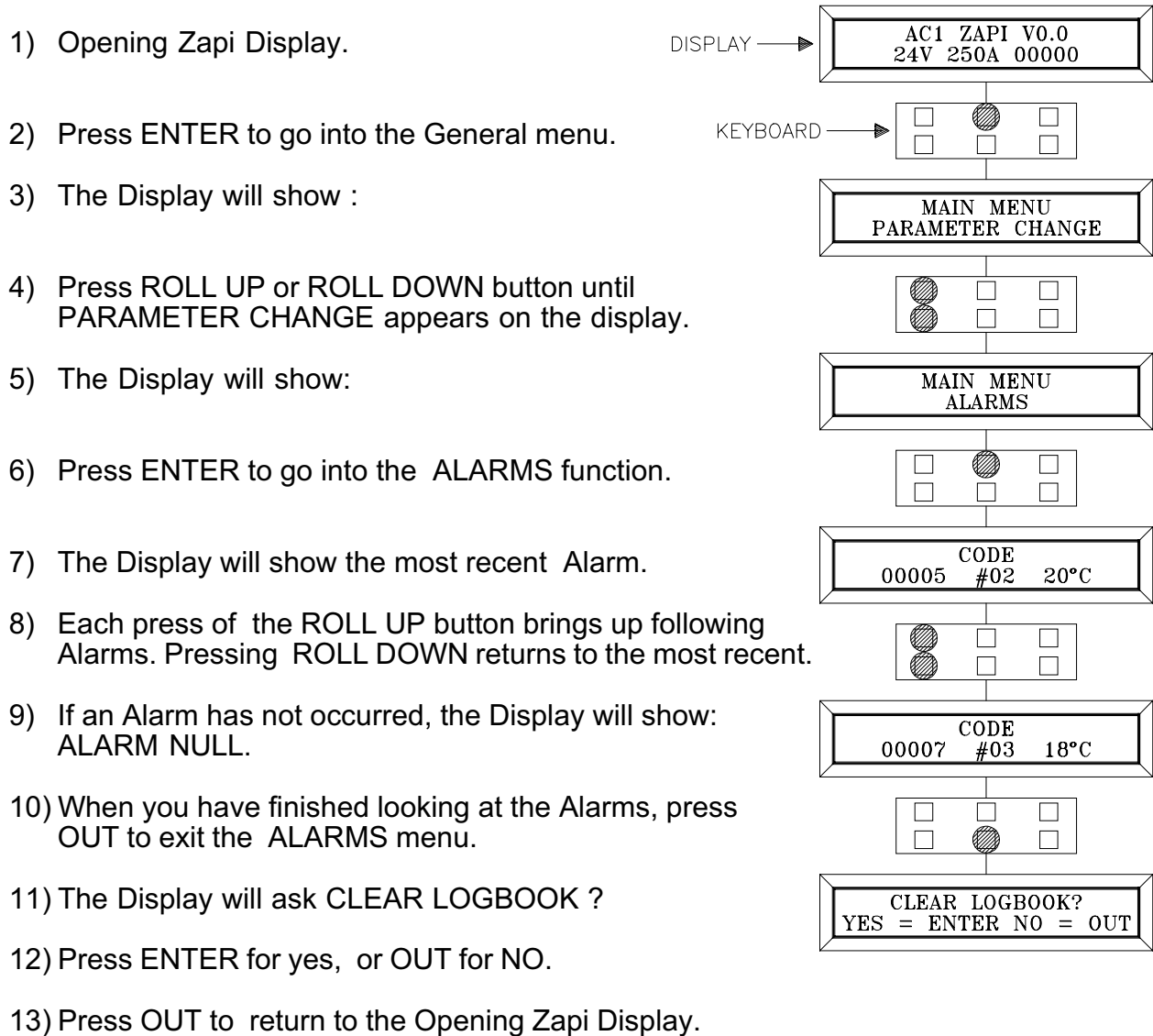

5.4 DESCRIPTION OF CONSOLE PROGRAM VACC FUNCTION

This function looks for and remembers the minimum and maximum potentiometer wiper voltage over the full mechanical range of the pedal. It enables compensation for non symmetry of the mechanical system between directions. The operation is performed by operating the pedal after entering the PROGRAM VACC function.

Flow Chart showing how to use the PROGRAM VACC function of the Digital Console.

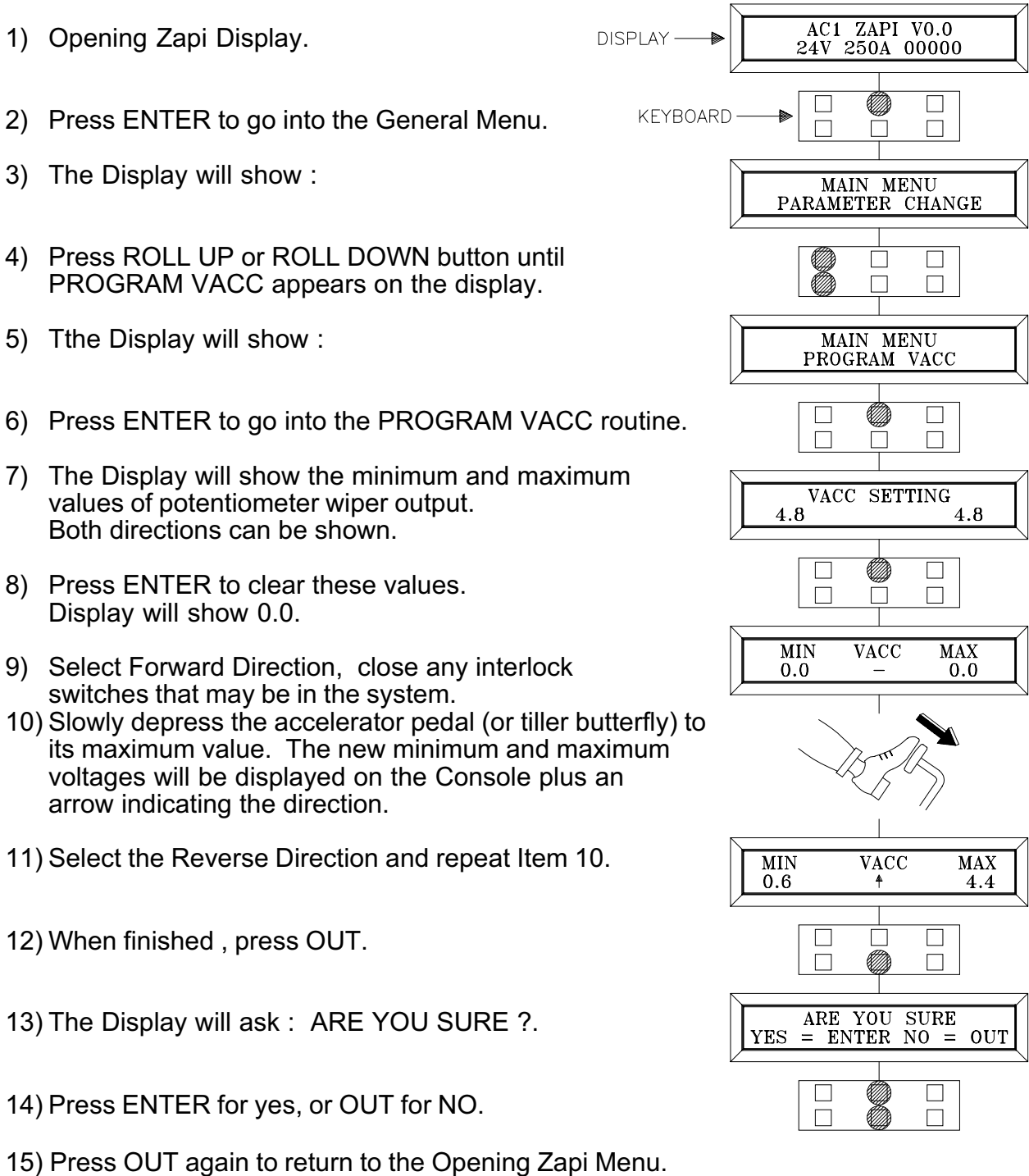

6 AC1 INVERTER DIAGNOSTIC

The alarms are signalled by a diagnostic LED.

1 blink:	logic failure ("WATCHDOG", "EEPROM KO", "LOGIC FAILURE #1", "LOGIC FAILURE #2", "LOGIC FAILURE #3", "CHECK UP NEEDED").
2 blinks:	running request on start-up or error in seat sequence or double direction request ("INCORRECT START", "HAND-BRAKE", "FORW + BACK").
3 blinks:	phase voltage or capacitor charge failure ("CAPACITOR CHARGE", "VMN LOW", "VMN HIGH").
4 blinks:	failure in accelerator ("VACC NOT OK", "PEDAL WIRE KO").
5 blinks:	failure of current sensor ("STBY I HIGH").
6 blinks:	failure of contactor driver ("COIL SHORTED", "DRIVER SHORTED", "CONTACTOR DRIVER", "AUX OUTPUT KO", "CONTACTOR OPEN", "PEV NOT OK", "MDI COIL SHORTED", "MDI NEG EVP", "MDI PEV", "MDI VALVE DRIVER", "MDI DRIVER SHORTED").
7 blinks:	excessive temperature ("HIGH TEMPERATURE", "THERMIC SENSOR KO").
8 blinks:	failure detection from can-bus ("CAN-BUS KO").
long blink:	discharge battery ("LOW BATTERY")

6.1 ANALYSIS OF ALARMS DISPLAYED ON CONSOLE

1. WATCH DOG
The test is made in both running and standby. It is a self-diagnosing test within the logic. If an alarm should occur, replace the logic.
2. EEPROM KO
Fault in the area of memory in which the adjustment parameters are stored; this alarm inhibits machine operation. If the defect persists when the key is switched OFF and ON again, replace the logic. If the alarm disappears, remember that the parameters stored previously have been cancelled and replaced by the default values.
3. LOGIC FAILURE #1
This alarm signals that an undervoltage / overvoltage protection operation has occurred. Two possible reasons:
 - a. A real undervoltage / overvoltage situation happened.
 - b. Fault in the hardware section of the logic board which manages the overvoltage protection. Replace the logic card.

4. **LOGIC FAILURE #2**
Fault in the hardware section of the logic board which manages the phase' s voltage feedback. Replace the logic board.
5. **LOGIC FAILURE #3**
Fault in the hardware section of the logic board which manages the hardware current protection. Replace the logic board.
6. **CHECK UP NEEDED**
This is a warning. It is an information for the user that the programmed time for maintenance is elapsed.
7. **INCORRECT START**
This alarm signals an incorrect starting sequence. Possible causes:
 - a. running microswitch failure;
 - b. error in sequence made by the operator;
 - c. incorrect wiring;
 - d. if the default persists, replace the logic.
8. **FORW + BACK**
The test is carried out continuously. An alarm is signalled when a double running request is made simultaneously. Possible causes:
 - a. defective wiring;
 - b. running microswitch failure;
 - c. incorrect operation;
 - d. if the defect persists, replace the logic.
9. **HANDBRAKE**
The truck does not start because the handbrake switch is opened. Possible causes:
 - a. defective wiring;
 - b. failure of the microswitch;
 - c. incorrect operation of the operator;
 If the defect persist , replace the logic.
10. **CAPACITOR CHARGE**
Follows the charging capacitor system:

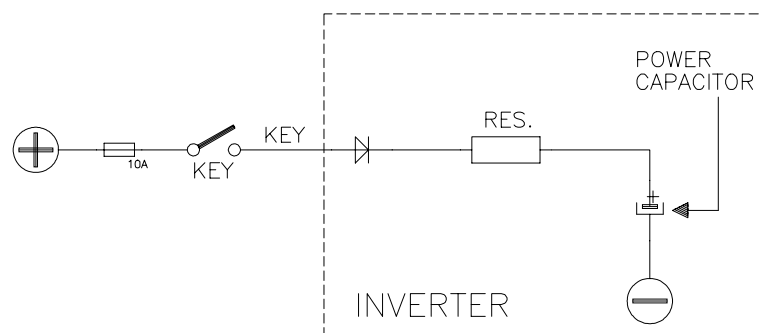

When the key is switched ON, the inverter tries to charge the capacitor through a power resistance, and check if the capacitor are charged within a timeout. If this is not true: an alarm is signalled; the main contactor is not closed.

Possible reasons:

- a) the charging resistance is opened; if it is opened.
- b) The charging circuit has a failure.
- c) There is a problem on the power modules.

11. VMN LOW, VMN HIGH

The test is carried out during initial diagnosis and in standby.

Possible causes:

- a. problem with the motor connections or the motor power circuit; check if the 3 phases are correctly connected; check if there's a dispersion of the motor towards ground;
- b. inverter failure, replace it.

12. VACC NOT OK

The test is made in standby. This alarm indicates that the accelerator voltage is 1V greater than the minimum value programmed by the PROGRAM VACC function.

Possible causes:

- a. the potentiometer is not correctly calibrated;
- b. the potentiometer is defective.

13. PEDAL WIRE KO

This alarm is signalled if a fault is detected in the accelerator unit wiring (NPOT or PPOT cable is interrupted).

14. PROG LIFT LEVER

This alarm is signalled if a fault is detected in the program of the lifting / lowering potentiometer (MDI PRC version only).

15. STBY I HIGH

Test carried out in standby. Check if the current is 0. If not verified, an alarm is signalled which inhibits machine operations. Possible causes:

- a. current sensor failure;
- b. logic failure: first replace the logic; if the defect persists, replace the power unit.

16. MAIN CONTACTOR ALARMS

COIL SHORTED:

When the key is switched ON the μ P checks the MC driver FF SR. If it does not react in a correct way to the μ P stimulus, the alarm is signalled. Replace the logic board.

The FF SR makes an hardware control of the current in the MC coil. If this is too high, it opens the MC and the alarm is signalled.

Check if there are external shortcircuit and if the ohmic value of the MC is correct; otherwise replace the logic.

DRIVER SHORTED:

When the key is switched ON, the μ P checks that the MC coil driver is not shorted; if it is, this allarm is signalled; replace the logic board.

CONTACTOR DRIVER:

When the initial diagnosis is finished, the traction logic closes the MC and checks the voltage on the Drain of the driver. If this is not low , an alarm is signalled.

Replace the logic.

CONTACTOR OPEN:

The main contactor coil has been driven by the logic board, but the contactor does not close. Two possible reasons:

- a) the wires to the coil are interrupted or not well connected.
- b) the contact of the contactor is not properly working.

17. AUX OUTPUT KO

The μ P checks the driver of the electromechanical brake. If the status of the driver output does not correspond to the signal coming from the μ P, the alarm is signalled. Replace the logic.

18. PEV NOT OK

The voltage of the "HM" output (Standard version) or the "PEV" output (MDI PRC version) is not correct.

Possible cause:

- a) output transistor is damaged.
- b) defect in the logic

19. MDI COIL SHORTED

This failure is detected by MDI PRC and the information is sent to AC1 by Can-Bus link. It means MDI PRC has detected a short-circuit on a coil of one of the On/Off valves. Possible reasons:

- a) the coil is really shorted or there is a wrong connection.
- b) problem in MDI PRC hardware.

20. MDI VALVE DRIVER

This failure is detected by MDI PRC and the information is sent to AC1 by Can-Bus link. It means that one of the On/Off valves driver is open.

21. MDI DRIVER SHORTED

This failure is detected by MDI PRC and the information is sent to AC1 by Can-Bus link. It means that one of the On/Off valves driver is shorted. Possible reasons:

- a) wrong external connection, check the wiring.
- b) problem in MDI PRC hardware.

22. MDI NEG EVP

This failure is detected by MDI PRC and the information is sent to AC1 by Can-Bus link. It means there is a problem on one of the two drivers of proportional valves.

23. MDI PEV

This failure is detected by MDI PRC and the information is sent to AC1 by Can-Bus link. It means MDI PRC has detected a wrong value of the electrovalves positive.

Possible reasons:

- a) wrong connection.
- b) problem on AC1 PEV output.
- c) problem in MDI PRC hardware.

24. HIGH TEMPERATURE

Chopper temperature is greater than 75°C. The maximum current is reduced proportionally to the temperature increase. The chopper stops at 100°C.

If the alarm is signalled when the chopper is cold:

- a) check the wiring of the thermal sensor;
- b) thermal sensor failure;
- c) logic failure.

25. THERMIC SENSOR KO

The range of inverter temperature sensor is always checked and a warning is signalled if it is out of range.

When this alarm is signalled, check the connection of the sensors.

26. CAN BUS KO

The diagnosis of the CAN-BUS line is present only if the inverter uses this link (depends on the software version). It is signalled if the inverter does not receive any message from the CAN-BUS line. First of all, check the wiring. If it is ok, the problem is on the logic board, which must be replaced.

27. BATTERY LOW

If the "battery check" option is ON, a battery discharge algorithm is carried out. When the charge level is 10% , this allarm is signalled and the current is reduced to the half of the programmed level.

7 RECOMMENDED SPARE PARTS FOR INVERTER

Part Number	Description
C29522	SW 180 48V Single Pole Contactor
C29508	SW 180 24V Single Pole Contactor

8 PERIODIC MAINTENANCE TO BE REPEATED AT TIMES INDICATED.

Check the wear and condition of the Contactors' moving and fixed contacts. Electrical Contacts should be checked every **3 months**.

Check the Foot pedal or Tiller microswitch. Using a suitable test meter, confirm that there is no electrical resistance between the contacts by measuring the volt drop between the terminals. Switches should operate with a firm click sound. Microswitches should be checked every **3 months**.

Check the Battery cables, cables to the chopper, and cables to the motor. Ensure the insulation is sound and the connections are tight. Cables should be checked every **3 months**.

Check the mechanical operation of the pedal or tiller . Are the return springs ok. Do the potentiometers wind up to their full or programmed level. Check every **3 months**.

Check the mechanical operation of the Contactor(s). Moving contacts should be free to move without restriction. Check every **3 months**.

Checks should be carried out by qualified personnel and any replacement parts used should be original. Beware of NON ORIGINAL PARTS.

The installation of this electronic controller should be made according to the diagrams included in this Manual. Any variations or special requirements should be made after consulting a Zapi Agent. The supplier is not responsible for any problem that arises from wiring methods that differ from information included in this Manual.

During periodic checks, if a technician finds any situation that could cause damage or compromise safety, the matter should be brought to the attention of a Zapi Agent immediately. The Agent will then take the decision regarding operational safety of the machine.

Remember that Battery Powered Machines feel no pain.

NEVER USE A VEHICLE WITH A FAULTY ELECTRONIC CONTROLLER.