



ELECTRONIC INDUSTRIAL DEVICES

42028 - POVIGLIO - (R.E.) - Via Parma, 59 - ITALIA
Tel. (0522) 960050 (r.a.) - Tlx. 530021 AINDRE I - Fax (0522) 960259

INSTALLATION AND USER MANUAL CHOPPER SEM2



INDEX

	Page
LEGEND	3
COLOUR CODES (Single Colours)	3
1 Introduction to the ZAPI-MOS family	4
2 General characteristic	5
2.1 Technical Specification	5
2.2 Control Units	5
2.2.a Microswitches	5
2.2.b Potentiometer	6
2.3 Safety & Protection Features.	7
2.4 Direction Orientation	7
2.5 Operational Features	8
2.6 SEM2 chopper diagnosis	9
2.7 Thermal Considerations.	9
2.8 General Instructions and Precautions	10
3 Installation.	11
3.1 Connection Cables.	11
3.2 Contactors.	11
3.3 Fuses.	11
3.4 Description of SEM 2 Connectors.	12
3.5 Description of Power Connections	14
3.6 Mechanical Drawing & Dimensions	15
4 Programming & Adjustments using Digital Console	16
4.1 Adjustments via Console	16
4.2 Description of Console & Connection	16
4.3 Description of Standard Console Menu	17
5 SEM2 Traction	18
5.1 Description of Programmable Functions (Options).	19
5.2 Description of Parameters that may be Programmed	21
5.3 Table of Adjustments	22
5.4 SEM 2 Traction Standard Wiring Diagrams	23
5.5 Sequence for SEM 2 Traction Settings.	24
6 SEM 2 Diagnostics	26
6.1 Analysis of Alarms displayed on the Console	27
6.2 Tester. Description of the Functions	30
6.3 Description of the Console SAVE Function	32
6.4 Description of Console RESTORE Function.	33
6.5 Description of Alarms Menu.	34
6.6 Description of Console PROGRAM VACC function.	35

7 Recommended Spare parts for SEM 2 36
8 Periodic Maintenance to be repeated at times indicated. 37

 = The information contained in the paragraphs marked with this symbol is essential for the purpose of safety.

SIGNED IN APPROVAL

COMPANY DEPT. SERVICES	MANAGEMENT EXECUTIVE
ENGINEERING SECTION EXECUTIVE	
EXPORT MANAGER	

LEGEND

BACK.FW	=	Inching forward direction switch
BACK.REV	=	Inching reverse direction switch
BTG	=	Main Contactor Coil
CMM	=	Common Feed to Microswitches
CPOT	=	Potentiometer Wiper
FORW	=	Forward switch
HB	=	Handbrake switch
KEY	=	Key switch input
NAUX	=	Negative supply for auxiliary load
NPOT	=	Potentiometer Negative supply
PAUX	=	Positive supply for auxiliary load
PB	=	Brake pedal switch
PPOT	=	Potentiometer Positive supply
REV	=	Reverse switch input
SR1	=	Speed Reduction 1 Microswitch
SR2	=	Speed Reduction 2 Microswitch
TG	=	Main Contactor
VMN	=	Voltage to Negative of Motor

COLOUR CODES (SINGLE COLOURS)

The following Codes represent the colours of individual wires used by Zapi (Unless specified otherwise).

A	-	Orange
B	-	White
BB	-	Blue
C	-	Sky Blue
G	-	Yellow
GG	-	Grey
M	-	Brown
N	-	Black
R	-	Pink
RR	-	Red
V	-	Green
VV	-	Purple

1 INTRODUCTION TO THE ZAPI-MOS FAMILY

The ZAPIMOS chopper family represents ZAPI's answer to the needs of the 90's. To ensure that products remain on the market, without running the risk of becoming technically obsolescent, the ZAPIMOS family offers the following features:

- Advanced technology.
- Economical costs.
- Maximum safety.
- Maximum flexibility.
- Open to future technical innovations.
- **Optimum level of protection.**

The design has been derived from:

- High Frequency Mos Technology .
- Real time control over the internal and external components that influence the behavior of the machine, with self diagnosis of the checking circuits themselves.
- Stored Program Machine (SPC), where the hardware is completely separate from the functions to be configured. The programme is parametric and can easily be modified by the end user.
- Various chopper configurations can be selected by the user, without the need for hardware modifications.
- Future technological updates are made easy for the user.

The communication protocol will continue to evolve, thereby offering increasing possibilities of interaction and expansion. For this reason, the Zapimos family offers a standard dialogue mode with external systems. This allows interfacing with

commercially available machines. Zapi can offer a range of individually designed Console Software with various features and prices.

- SEM 2 meets the requirements of (IP54). This provides excellent protection against spray (water, acid.), and against the ingress of dust or small foreign particles. Access to the control logic is very simple, and allows simple substitution or replacement.
- The SEM2 family of Choppers are suitable for operating on DC voltages from 24 to 48V inclusive, with maximum armature current up to 350A. The choppers may be used to control DC Separately Excited Motors with power ratings up to 5.5kW.

2 GENERAL CHARACTERISTIC

2.1 TECHNICAL SPECIFICATION

Chopper for Separately Excited DC motors	2.5 ÷ 5.5kW
Regenerative Braking.	
Voltage Range	24 to 48 Volts DC
Maximum Field Current (all the versions)	50 Amps
Armature Switching Frequency	16kHz
Field Switching Frequency	1kHz
Maximum Ambient temperature	+ 40°C
Minimum Ambient temperature	-30°C
Maximum temperature of Chopper	+ 85°C
Resistance of field Winding	0.3 to 0.6W

VERSION	MAXIMUM CURRENT	BOOSTER CURRENT	VOLTAGE DROP AT TOTAL CONDUCTION
24V / 500A	500A	580A	0.25V at 200A, 25°C
36V / 500A	500A	580A	0.25V at 200A, 25°C
48V / 350A	350A	400A	0.25V at 100A, 25°C

2.2 CONTROL UNITS

2.2.a Microswitches

- Microswitches should have a contact resistance lower than 0.1W , and a leakage current lower than 100 µA.
- When full load current is being drawn, the voltage drop across the Key Switch contacts must be lower than 0.1V.
- If an Electromagnetic Brake is used, the Handle Microswitch must operate the Brake Coil.
- The Microswitches send a voltage signal to the microprocessor when an operating request (running) is made.

2.2.b Potentiometer

The Potentiometer should be wired in the 3 - Wire Configuration.

CPOT (A2) signal ranges from 0 to 10V.

Minimum Potentiometer Resistance : 500 Ω

Maximum Potentiometer Resistance : 10k Ω

Faults can occur if the potentiometer is out of this range.

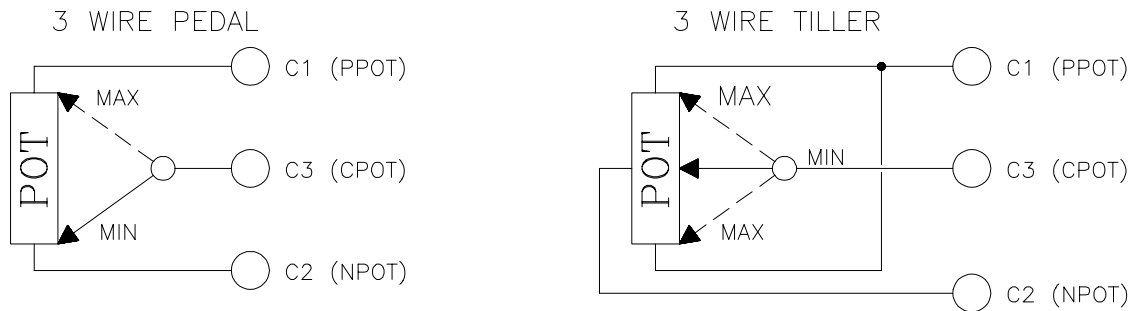

The Procedure for automatic potentiometer signal acquisition is carried out using the Console. This enables adjustment of the minimum and maximum useful signal level in either direction. This function is unique when it is necessary to compensate for asymmetry with the mechanical elements associated with the potentiometer, especially relating to the minimum level.

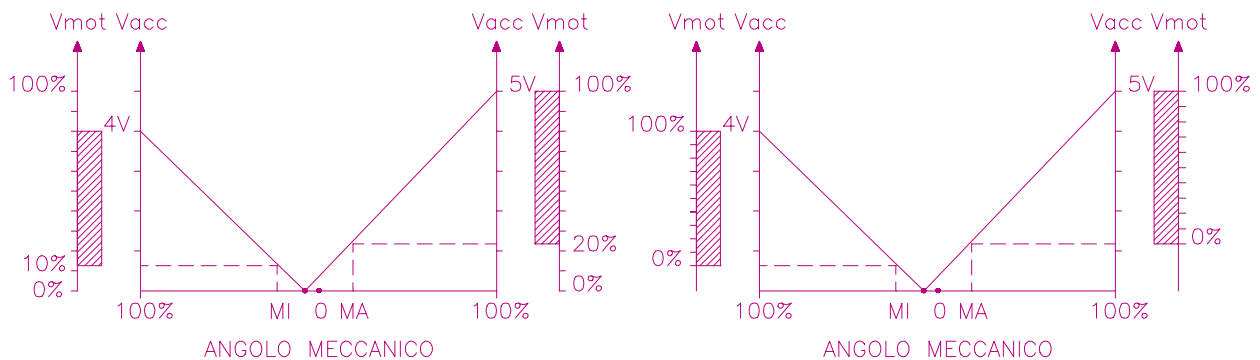

The two graphs show the output voltage from a non-calibrated potentiometer with respect to the mechanical “zero” of the control lever. MI and MA indicate the point where the direction switches close. 0 represents the mechanical zero of the rotation.

The Left Hand graph shows the relationship of the motor voltage without signal acquisition being made. The Right Hand Graph shows the same relationship after signal acquisition of the potentiometer.

The acquisition procedure is disabled if the potentiometer wiper output does not reach a minimum of 3 V. If a centre tapped potentiometer is not available, it is possible to use a standard 3 wire pot set in the middle of its full stroke.

2.3 SAFETY & PROTECTION FEATURES.

- **Connection Errors :**

All Inputs are protected against connection errors.

- **Thermal Protection :**

If the chopper temperature exceeds 80°C, the maximum current reduces in proportion to the thermal increase. The temperature can never exceed 85°C.

- **Low Battery Charge :**

When the battery charge is low, the maximum current is reduced proportionally to the battery discharge.

- **Protection against accidental Start up :**

A precise sequence of operations are necessary before the machine will start. Operation cannot commence if these operations are not carried out correctly. Requests for drive, must be made after closing the key Switch.

- **Protection against uncontrolled movements :**

The Main Contactor will not close if :

- The Power Unit is not functioning
- The Logic is not functioning perfectly.

- **Main Contactor :**

Should be fitted to give protection to the chopper against reverse battery polarity, and safety.

- **External Agents :**

The chopper is protected against dust and the spray of liquid to a degree of protection meeting IP54.

2.4 DIRECTION ORIENTATION

Machines fitted with Tillers, Belly Switches, and Pulse Control Systems providing rapid reversal should conform to the requirements of Directive prEN 1175. This Directive requires that Direction Orientation should match the following drawing:

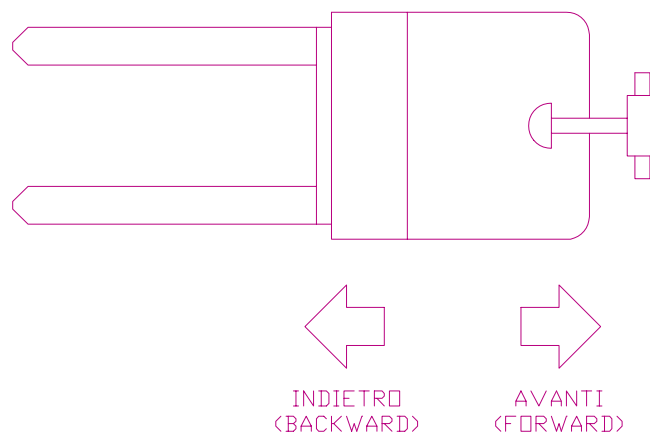

2.5 OPERATIONAL FEATURES

- Speed Control .
- Optimum sensitivity at low speeds.
- Speed Reductions in both the directions. Levels can be set using Console.
- Regenerative Braking based on deceleration ramps.
- Three different modes of Braking : Release Braking, Inversion Braking, Speed Limit Braking.
- Speed Control during descent : the motor speed follows the accelerator. The chopper automatically brakes if the motor speed overcomes the accelerator set point. This provides optimum performance on a gradient.
- Starts on a Ramp without roll back, even without an electric brake.
- Programmable Anti Roll Back : When the Key Switch is closed, if the motor is rotating, the chopper controls the speed and automatically brakes and keeps the motor at a very low speed during descent on a gradient. This is a very useful safety feature and is not driver dependent.
- Self Diagnosis with indication of fault shown via flashing Red Led. (In addition to Console Display).
- Modification of the parameters via Digital Console. See the specific description.
- Internal Hour Meter that is displayed on the Console.
- Memory of the last 5 Alarms, with relative Hour meter count and chopper temperature all displayed on the Console.
- Test Function within Console for checking main parameters. See the specific Description.
- High motor and battery efficiency due to High Frequency Switching.
- Presence of a second microprocessor for safety that monitors the CPU that controls the motor.

2.6 SEM2 CHOPPER DIAGNOSIS

The microprocessor continually monitors the chopper and carries out diagnostic procedures on the main functions.

The diagnosis is made in 4 points:

- 1) Diagnosis on key Switch closing that checks: the Watch Dog Circuits, the current sensor, VMN point, Contactor Drivers, the switch sequence for operation is correct, and the output of the accelerator or tiller is correct.
- 2) Standby Diagnosis at rest that checks: VMN Point, Contactor Drivers, and Current Sensor.
- 3) Diagnosis during operation that checks: Watchdog, VMN Point, Current, Contactor(s), and VMN when in full conduction.
- 4) Continuous Diagnosis that checks: Chopper temperature, Battery Voltage.

Diagnosis is provided in 2 ways. The Red Led connected to Connector A will flash a certain number of times for a given Alarm (See Listings), or the Digital Console may be used. A permanent Alarm will be displayed on the Console immediately and the RED LED will flash. An intermittent Alarm will be recorded in the Alarm library, but the RED LED will only flash at the time of the Alarm.

2.7 THERMAL CONSIDERATIONS.

- The heat generated by the power block must be dissipated. For this to be possible, the compartment must be ventilated and the heat sink materials ample.
- The heat sink material and system should be sized on the performance requirement of the machine. Abnormal ambient air temperatures should be considered. In situations where either ventilation is poor, or heat exchange is difficult, forced air ventilation should be used.
- The thermal energy dissipated by the power block module varies and is dependent on the current drawn and the duty cycle.

2.8 GENERAL INSTRUCTIONS AND PRECAUTIONS

- Never combine SCR low frequency choppers with SEM2 modules. The filter capacitors contained in the SEM2 module will change the SCR chopper operation and subject it to excessive workload. If it is necessary to use two or more control units (eg. Lift + traction), the choppers must be of the High Frequency Zapi family.
- Do not connect the chopper to a battery with a different nominal voltage to the value indicated on the chopper. A higher battery voltage may cause MOS failure, and a lower voltage may prevent the logic operating.
- During battery recharge, the SEM2 must be completely disconnected from the battery. As well as altering the charge current read by the battery charger, the module can be damaged by higher than normal voltages supplied via the charger.
- The SEM2 module should only be supplied by a traction battery. Do not use the outputs of convertors or power supplies. For special applications please contact the nearest Zapi service centre.
- Start the machine the first time with the drive wheel(s) raised from the floor to ensure that any installation errors do not compromise safety.
- After operation, even with the Key Switch open, the internal capacitors may remain charged for some time. For safe operation, we recommend that the battery is disconnected, and a short circuit is made between Battery Positive and Battery negative power terminals of the chopper using a Resistor between 10W and 100W. Minimum 5 W.
- The susceptibility and electromagnetic emission levels are seriously influenced by installation conditions. Take particular care with the length of cables and wires, types of electrical connections, and braided/screened wires. Zapi declines any responsibility for incorrect or bad operation that can be attributed to the above circumstances. Above all, the manufacturer of the machine must ensure that the requirements of EN 50081-2 are met.

3 INSTALLATION.

Install the chopper baseplate onto a flat metallic surface that is clean and unpainted. Apply a thin layer of thermo-conductive grease between the two surfaces to permit better heat dissipation.

Despite the protection provided against external agents, the continuous attack of corrosive elements and substances may cause oxidization of connector contacts, resulting in bad operation. Remember this point when deciding the installation position on the vehicle.

Fix the chopper using the special holes located on the baseplate.

Verify that the wiring of the cable terminals and connectors has been carried out correctly. Ensure that suppression devices are fitted to the Horn, Solenoid Valves, the coils of any relays, and contactors not supplied by logic or the chopper itself.

3.1 CONNECTION CABLES.

For the auxiliary circuits use cables better or equal to 0.5mm² section.

For power connections to the motor armature and battery use cable of 25 to 35mm² section.

For the Field connections use cable of 4mm² section.

For the optimum chopper performance, the cables to the battery should be run side by side and be as short as possible.

3.2 CONTACTORS.

A Main Contactor, designed for Continuous Operation should be installed. This contactor should be fitted with a coil corresponding to the battery voltage. The current absorbed by the coil must not be greater than 3A.

Suppression for this contactor coil is within the chopper. Do not use external suppression. If contactors for power steer motors are supplied from the control logic, the suppression will be inside the chopper logic.

For any Contactor using external suppression, ensure that connections are made respecting correct polarity.

3.3 FUSES.

- Use a 6.3A Fuse for protection of the auxiliary circuits.
- For protection of the power unit, refer to diagrams.. The Fuse value shown is the maximum allowable. For special applications or requirements these values can be reduced.
- For Safety reasons, we recommend the use of protected fuses in order to prevent the spread of fused particles should the fuse blow.

3.4 DESCRIPTION OF SEM 2 CONNECTORS.

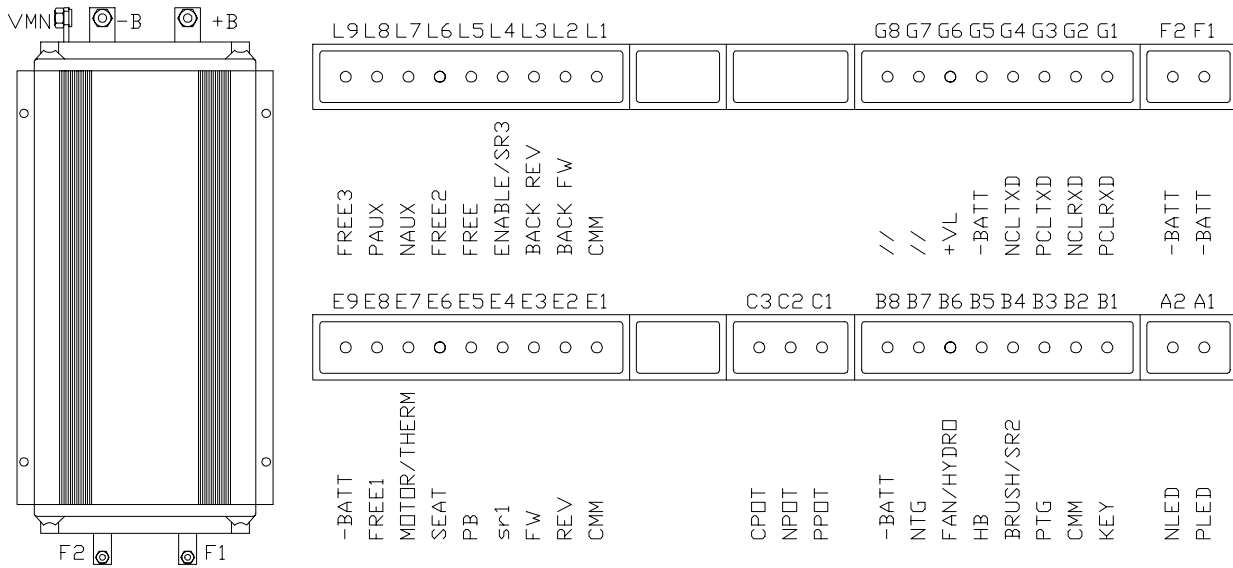

PIN REFERENCE DESCRIPTION

- | | | |
|---|-------------|---|
| A1 | PLED | Positive of Diagnostic Red Led. |
| A2 | NLED | Negative of Diagnostic Red Led. |
| Output Current is 12mA, for this standard type Led. | | |
| | | |
| B1 | KEY | B+ Supply into logic Downstream of 10A Fuse & Key Switch. |
| B2 | CMM | Positive Supply to Hand Brake and Brush / SR2 Microswitches. |
| B3 | PTG | Positive Supply to Main Contactor. |
| B4 | BRUSH / SR2 | Input from motor brush switch (normally open), or Input from second speed reduction switch (normally closed). |
| B5 | HB | Input from Hand Brake Switch (normally closed). |
| B6 | FAN / HYDRO | Negative Output to Fan or Power Steer Contactor Coil. |
| B7 | NTG | Negative Supply to Main Contactor. |
| B8 | - BATT | Battery Negative. |
| | | |
| C1 | PPOT | Positive Output to Potentiometer (I max = 25mA). |
| C2 | NPOT | Negative Output to Potentiometer. |
| C3 | CPOT | Input from Potentiometer Wiper, or output of inductive device. |

PIN REFERENCE DESCRIPTION

E1	CMM	Positive Common Feed to Rev, Fwd, SR1, PB, and Seat Microswitches.
E2	REV	Input from Reverse Direction Microswitch. Active High.
E3	FW	Input from Forward Direction Microswitch. Active High.
E4	SR1	Input from First Speed Reduction Switch. Active Low.
E5	PB	Input from Pedal Brake Switch. Active High.
E6	SEAT	Input from Seat Switch. Active High with delay.
E7	MOT. THERM	Input from Motor Thermal Switch.
E8	FREE1	Input from any Active High Switch.
E9	- BATT	Battery Negative.
F1	- BATT	Battery Negative.
F2	- BATT	Battery Negative..
G1	PCLRXD	Positive Serial Reception.
G2	NCLRXD	Negative Serial Reception.
G3	PCLTXD	Positive Serial Transmission.
G4	NCLTXD	Negative Serial Transmission.
G5	- Batt	Negative supply to Digital Console.
G6	+ VL	Positive supply to Digital Console.
G7	//	Free.
G8	//	Free.
L1	CMM	Common Supply to Fwd & Rev Backing Switches, Motor thermal switch, Speed Reduction 3 Switch, and 2 spare switches.
L2	BACK FW	Input from Forward Backing Switch. Active High.
L3	BACK REV	Input from Reverse Backing Switch. Active High.
L4	ENABLE/ SR3	Input from pedal accelerator (Enable) Active High.or Speed Reduction 3 Switch Active Low.
L5	FREE	Input from Free Microswitch 1. Active High.
L6	FREE2	Input from Free Microswitch 2. Active High.
L7	NAUX	Negative Output to Auxilliary.
L8	PAUX	Positive Output to Auxiliary.
L9	FREE3	Free Entry 3. Connected to CMM (if J1= 2-3) or to- Batt (if J1= 1-2) through microswitch.

NOTES:

- 1) The BRUSH / SR2 and HB inputs could be connected to Battery Negative (B8). It is necessary to change the internal link "B" from 1-2 to 2-3. In this case the Normally Closed microswitches need to be Normally Open, and the Normally Open microswitches need to be Normally Closed.
- 2) The REV, FW, SR1, PB, SEAT inputs could be connected to Battery Negative (E9). It is necessary to change the internal link "A" from 1-2 to 2-3. In this case the Normally Closed microswitches need to be Normally Open, and the Normally Open Microswitches need to be normally Closed.
- 3) The MOTOR THERM, BACK FW, BACK REV, ENABLE/ SR3, FREE inputs could be connected to Battery Negative (F1 or F2). It is necessary to change the internal link "C" from 1-2 to 2-3. In this case the Normally Closed microswitches need to be Normally Open, and the Normally Open Microswitches need to be Normally Closed.

3.5 DESCRIPTION OF POWER CONNECTIONS

- +BATT** = Positive Supply from Battery.
-BATT = Negative Supply from Battery.
VMN = Negative Supply (via chopper) to Motor.
F1, F2 = Connections to Drive Motor Field Winding.

3.6 MECHANICAL DRAWING & DIMENSIONS

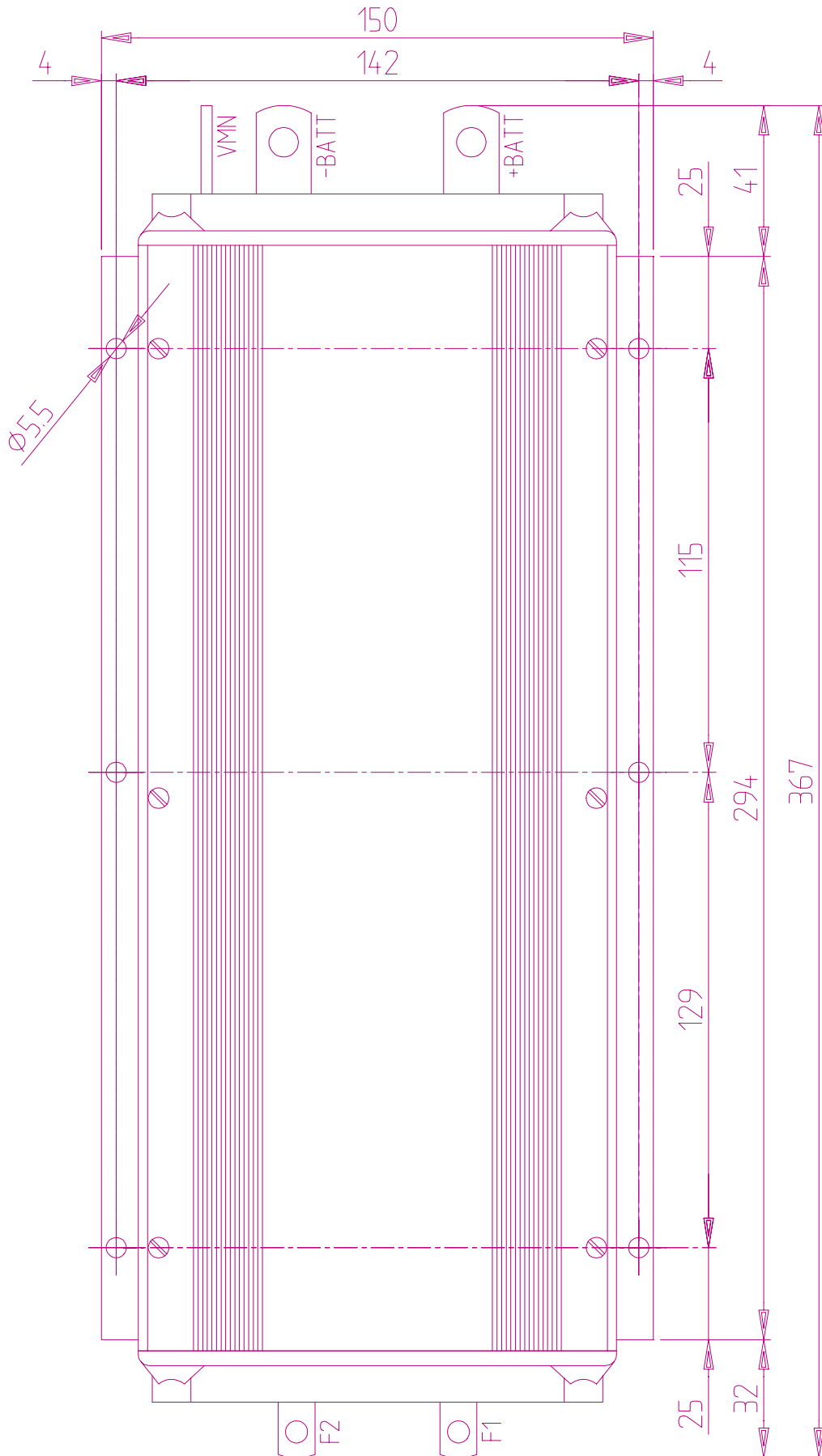

4 PROGRAMMING & ADJUSTMENTS USING DIGITAL CONSOLE

4.1 ADJUSTMENTS VIA CONSOLE

Adjustment of Parameters and changes to the chopper's configuration are made using the Digital Console. The Console is connected to the "G" connector of the SEM 2 Chopper.

 **Pay attention to the polarity of the Console Connector when connecting to the chopper. The bevel on the connector should be uppermost.**

4.2 DESCRIPTION OF CONSOLE & CONNECTION

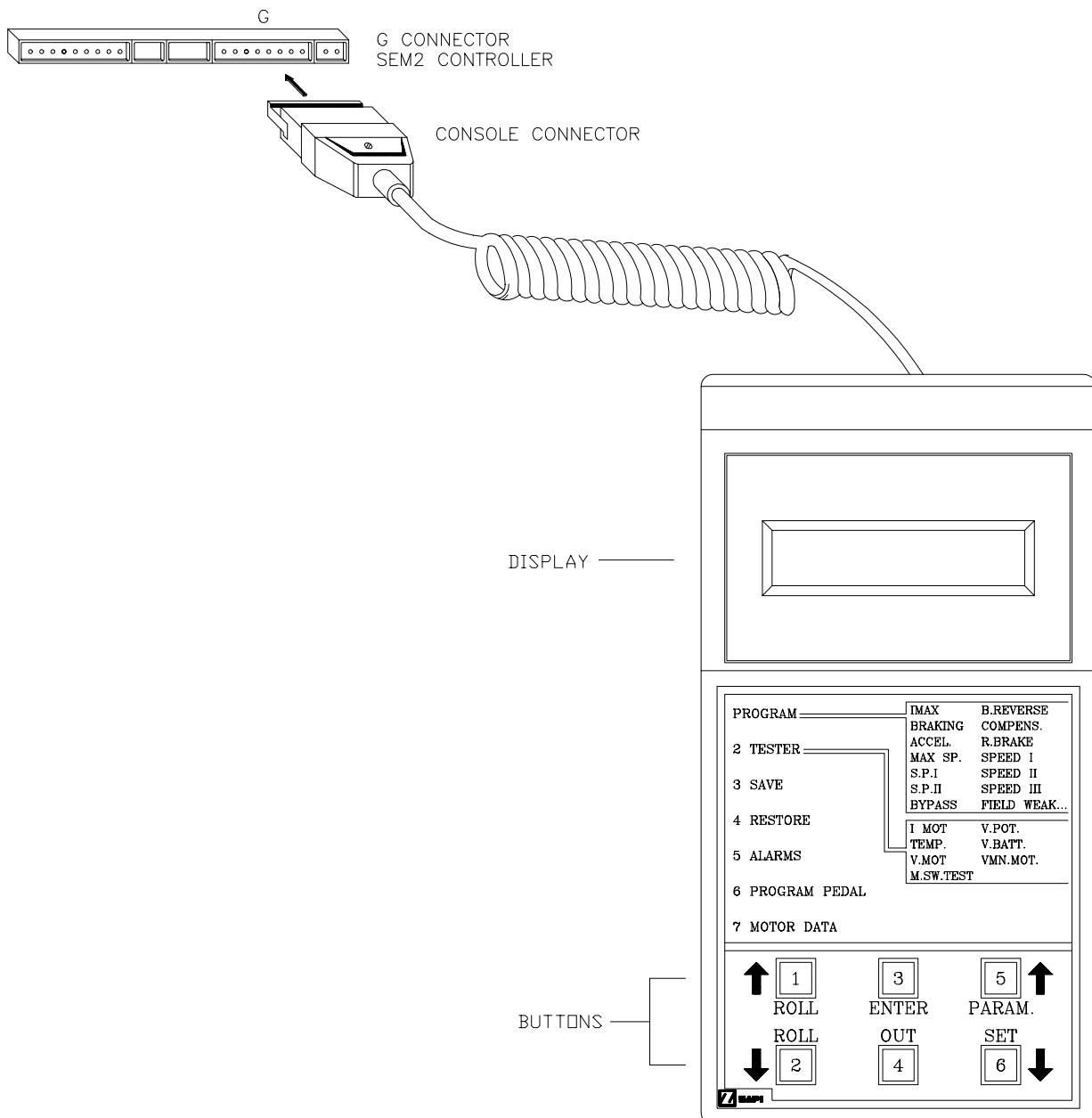

Digital Consoles used to communicate with SEM2 choppers must be fitted with Eprom CK ULTRA.

4.3 DESCRIPTION OF STANDARD CONSOLE MENU

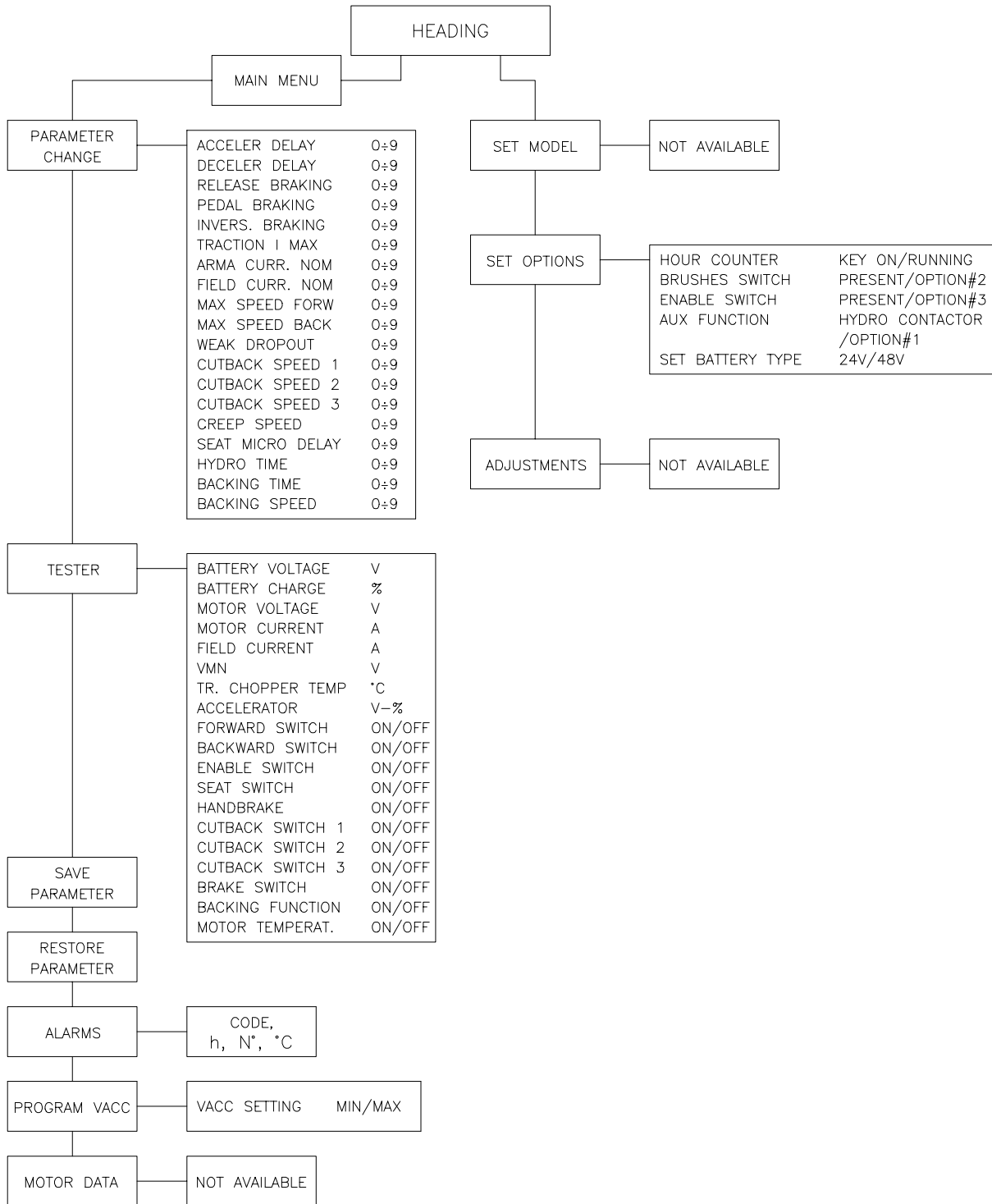

5 SEM2 TRACTION

- Input for 3 Wire Potentiometer.
- 3 Speed Reductions.
- Input for Tiller Switch or Seat Switch (delayed).
- Input for Brake Pedal Microswitch.
- Input for Motor Thermal Switch.
- Management of Backing Speed (Programmable).

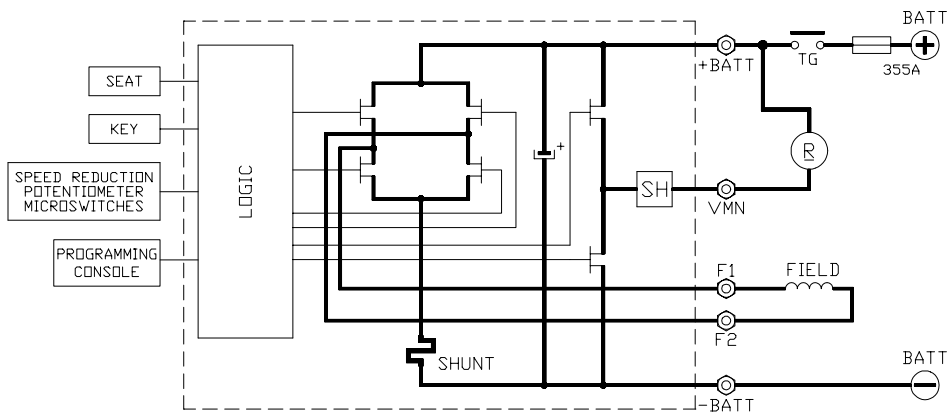
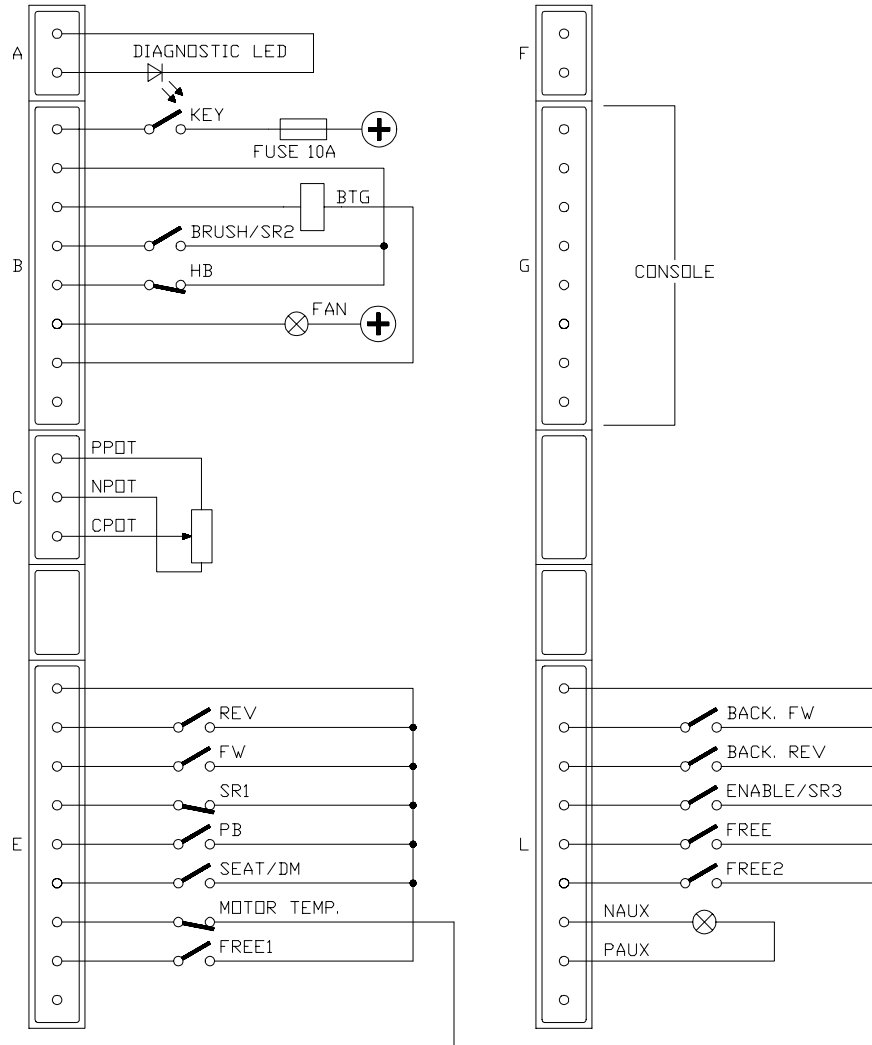

5.1 DESCRIPTION OF PROGRAMMABLE FUNCTIONS (OPTIONS).

Using the CONFIG MENU of the console, it is possible to select from the following options:

SUBMENU "SET OPTIONS":

1 HOUR COUNTER:

- RUNNING: The counter registers travel time only.
- KEY ON: The counter registers when the key switch is Closed.

2 BRUSH SWITCH:

- PRESENT: The Brush Switch provides an input signal from the motor brushes.
- OPTION #2: The Brush Switch Input may be used as a Second Speed Reduction.

3 ENABLE SWITCH:

- PRESENT: The Enable Switch provides an input from the pedal accelerator.
- OPTION #3: The Enable Switch input may be used as a Third Speed Reduction.

4 AUX FUNCTION:

- OPTION #1: The output on Pin B6 provides a Negative supply to a fan.
- HYDRO CONT.: The output on Pin B6 provides a Negative supply to the coil of a steering Contactor.

5 SET BATTERY TYPE:

This option allows selection of the Nominal Battery Voltage.

Flow Chart showing how to make changes to Configuration Menu using Digital Console. (Standard Eprom CK ULTRA fitted).

- 1) Opening Zapi Menu.
- 2) Press Top Left & Top Right Buttons simultaneously to enter the Config.Menu.
- 3) The Display will show :
- 4) Press ROLL UP (Top Left Button) until SET OPTIONS appears.
- 5) The Display will show :
- 6) Press ENTER to go into this part of the menu.
- 7) The first "Option" of the menu appears on the Display.
- 8) Press either ROLL UP or ROLL DOWN to bring up the next the Option.
- 9) A new Option appears on the Display.
- 10) When the desired Option is displayed, press PARAM (Top Right) or SET (Bottom Right) button to change the configuration
- 11) The new Configuration for the selected Option appears on the Display.
- 12) Press OUT to exit the Menu.
- 13) Press ENTER to accept the changes, or Press OUT if you do not accept the changes and wish to make further modifications to the particular Option.
- 14) The Display now shows:
- 15) Press OUT again. Display now shows the Opening Zapi Menu.

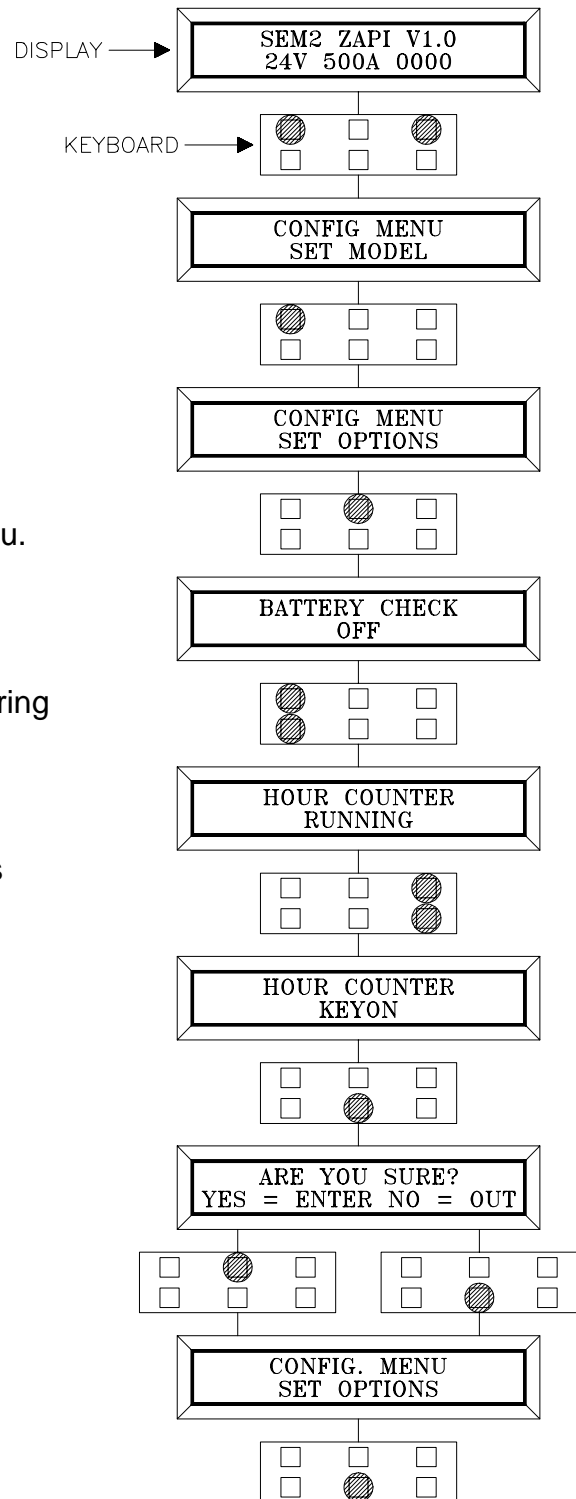

If any changes are made to the Configuration, it is necessary to Open and Re-Close the Key Switch before the Display will show the new, stored, changes.

5.2 DESCRIPTION OF PARAMETERS THAT MAY BE PROGRAMMED

In addition to the Configuration, Parameter settings may be made by Zapi using standard default settings, settings to Customer Specifications, or the customer may make changes according to the application, using a Digital Console.

During the setting up procedure on the machine, the Console can remain connected to the chopper during travel. The Parameters can be modified in real time, during operation.

Pay attention to the polarity of the Console Connector. Refer to Page 16 of this Manual for connection details.

The following Parameters can be modified :

- 1 **ACC. DELAY** = Determines the acceleration ramp.
- 2 **DECELER DELAY** = Determines the deceleration ramp according to the accelerator pedal position.
- 3 **RELEASE BRAKING** = Determines the deceleration ramp when the travel request is released.
- 4 **PEDAL BRAKING** = Determines the deceleration ramp when the brake pedal is operated during travel.
- 5 **INVERSION BRAKING** = Determines the deceleration ramp the the Direction Switch is inverted during travel.
- 6 **TRACTION IMAX** = Maximum Current of the Chopper (A).
- 7 **ARMA NOM.CURR.** = Nominal Armature Current. This parameter fixes a limit for the armature current above which the Field Current is at least the Nominal Value (FIELD NOM.CURR.), regardless of accelerator position.
- 8 **FIELD NOM. CURR.** = Nominal Field Current. This parameter fixes the minimum Field Current when the potentiometer is between 0% and 60% without total conduction of the Armature. Adjustment should be made with reference to the Data on the Motor Label. (The indication of Nominal Field Current).
- 9 **MAX SPEED FORW** = Maximum Forward Speed, obtained by weakening the Field Current after it has reached 100% conduction of the Armature. With the Parameter set at level 0, the armature is in total conduction but the field current does not decrease below the Nominal value (low speed).
- 10 **MAX SPEED BACK** = Maximum Reverse Speed, obtained by weakening the Field Current after it has reached 100% conduction of the Armature. With the Parameter set at level 0, the armature is in total conduction but the field current does not decrease below the Nominal value (low speed).
- 11 **WEAK DROPOUT** = This Parameter fixes a limit on the Armature Current above which the Field Current is increased linearly up to the Nominal Field Current (in proportion to the armature current).
- 12 **CUTBACK SPEED 1** = First Speed Reduction.
- 13 **CUTBACK SPEED 2** = Second Speed Reduction. This Parameter is configured in the SET OPTION Menu.
- 14 **CUTBACK SPEED 3** = Third Speed Reduction. This Parameter is configured in the SET OPTION Menu.

- 15 CREEP SPEED** = Minimum Speed. This Parameter sets the minimum voltage applied to the motor at the start of travel.
- 16 SEAT MICRO DELAY** = Delay time after Seat Microswitch has opened.
- 17 HYDRO TIME** = Operating time for Steering Contactor after controller has operated. This Parameter is configured in the SET OPTION Menu.
- 18 BACKING TIME** = Operation time of the BACKING Function.
- 19 BACKING SPEED** = Drive Motor Speed during the BACKING function. The chart on Page 23 shows the different values to which the parameters may be adjusted.

5.3 TABLE OF ADJUSTMENTS

The following Table shows the different values that the SEM2 Parameters may be adjusted to. A suitable acceleration performance assumes: FIELD CURR. NOM is set to level 5, and MAX SPEED (Fwd or Rev) is set to level 9.

PARAMETERS (24/48V VERSION)	PROGRAMMED LEVEL										
	UNIT	0	1	2	3	4	5	6	7	8	9
ACC. DELAY	sec.	0.3	0.6	0.9	1.3	1.6	1.9	2.3	2.5	2.8	3.1
DEC. DELAY	*	0	1	2	3	4	5	6	7	8	9
RELEASE BRAKING	*	0	1	2	3	4	5	6	7	8	9
PEDAL BRAKNG	*	0	1	2	3	4	5	6	7	8	9
INVERS BRAKING	*	0	1	2	3	4	5	6	7	8	9
TRACTION I MAX	%IMax	82	84	85	87	89	91	93	95	97	100
ARMA CUR. NOM. (ACN)	%IMax	32	35	38	41	44	47	50	53	56	58
FIELD CURR. NOM. (FCN)	A	12	13	14	15	16	17	18	19	20	21
MAX SPEED FORW.	%FCN	100	82	65	55	50	45	40	35	32	30
MAX. SPEED BACK.	%FCN	100	82	65	55	50	45	40	35	32	30
WEAK DROP OUT	%ACN	35	40	45	50	55	60	65	70	75	80
CUTBACK SPEED 1	%ACC	20	25	30	40	45	50	55	60	70	80
CUTBACK SPEED 2	%ACC	20	25	30	40	45	50	55	60	70	80
CUTBACK SPEED 3	%ACC	20	25	30	40	45	50	55	60	70	80
CREEP SPEED	%VBatt	3	5	7	9	11	13	15	17	19	21
SEAT MICRO DELAY	sec.	0.5	0.7	0.9	1.1	1.4	1.6	1.8	2.0	2.2	2.5
HYDRO TIME	sec.	0	0.5	1.0	1.6	2.2	2.7	3.2	3.8	4.4	5.0
BACKING TIME	sec.	0.05	0.2	0.3	0.5	0.8	1.0	1.5	2.0	2.5	3.0
BACKING SPEED	%VBatt.	32	40	45	52	58	65	72	78	85	90

*= If the current inclines to raise, then also the braking time raises in order to obtain a smooth braking action. Therefore, the duration of the braking depends on the type of motor and the operating conditions (laden, unladen, on plane, on gradient).

Flow Chart showing how to make Programme changes using Digital Console fitted with Eprom CK ULTRA.

1) Opening Zapi Display.

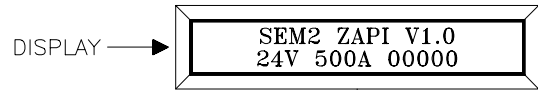

2) Press ENTER to go into the General Menu.

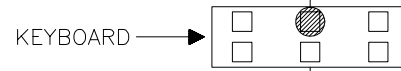

3) The Display will show :



4) Press ENTER to go into the Parameter Change facility.

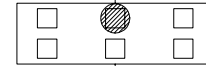

5) The Display will show the first Parameter.

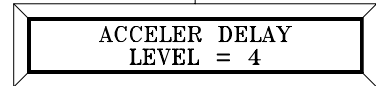

6) Press either ROLL UP and ROLL DOWN to display the next parameter.

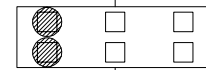

7) The names of the Parameters appear on the Display.

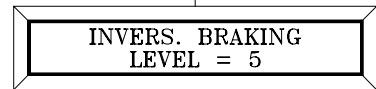

8) When the desired Parameter appears, the Display will show a Level Number that will be between 0 and 9. press either PARAM (Top Right) or SET (Bottom Right) buttons to change the Level value.



9) The Display will show the New Level.

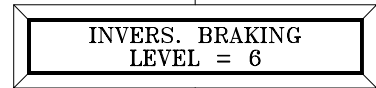

10) When you are satisfied with the results of the changes you have made, Press OUT.

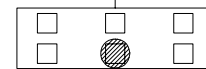

11) The Display asks " ARE YOU SURE ?

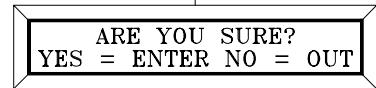

12) Press ENTER to accept the changes, or Press OUT if you do not wish to accept the changes and wish to make further modifications to the parameters.



13) The Display will show :



5.4 SEM 2 TRACTION STANDARD WIRING DIAGRAMS

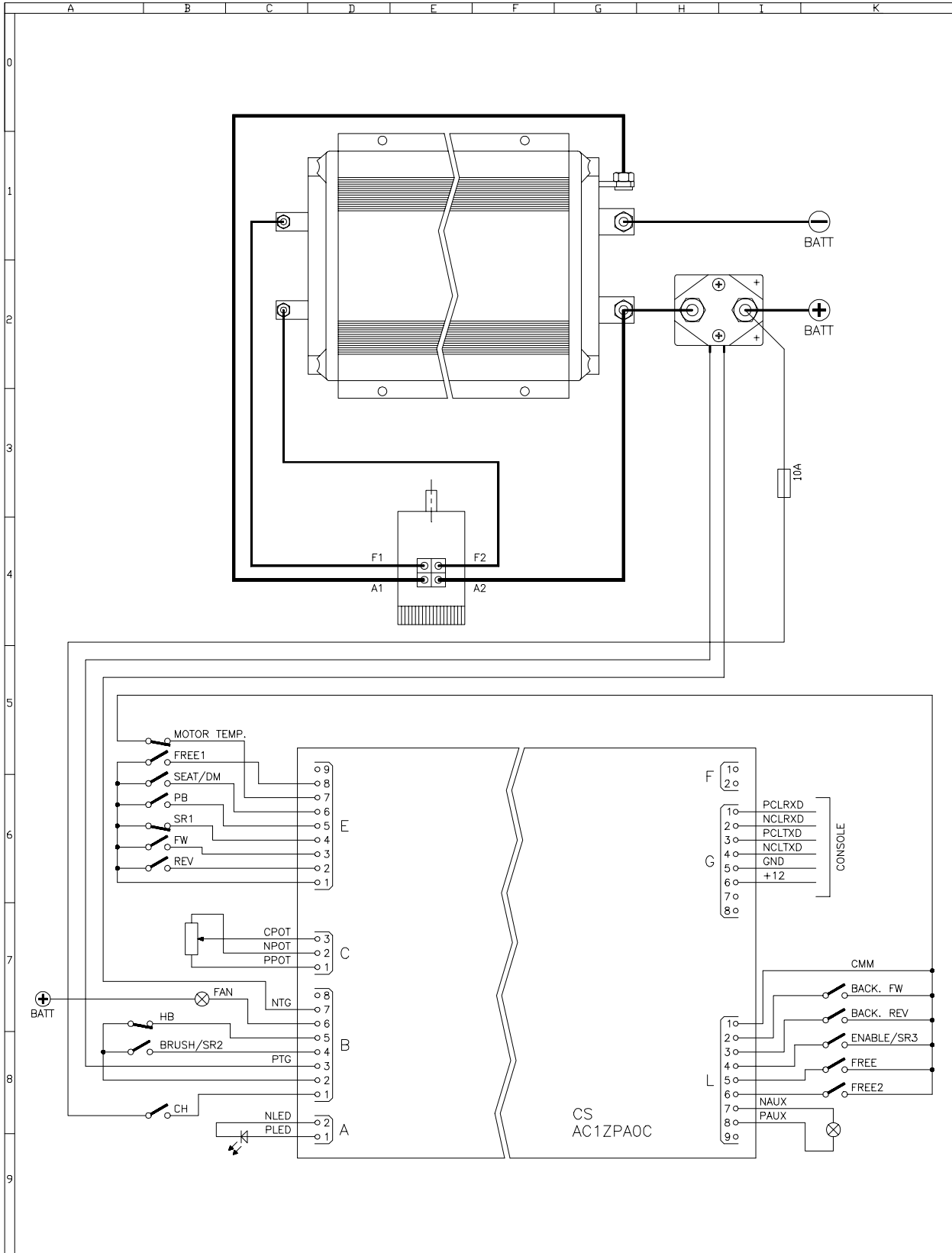

THIS DRAWING IS A ZAPI s.p.a. PROPERTY. ITS REPRODUCTION IS PROHIBITED EXCEPT FOR A WRITTEN AUTHORIZATION. THE ONLY ALLOWED USE IS THAT RELATIVE TO THE REPAIRS OF ZAPI PRODUCTS

CHOPPER SEM2 WIRING DIAGRAM

ZAPI s.p.a. 42028 PORGIO-ITALY	Date 26/06/97	Tecnico LC		Serie SEM	Number AC1ZP40D	Page 1.1
--	------------------	---------------	--	--------------	--------------------	-------------

5.5 SEQUENCE FOR SEM 2 TRACTION SETTINGS.

When the Key Switch is Closed, if no Alarms or Errors are present, the Console Display will be showing the Standard Zapi Opening Display.

If the chopper is not Configured to your requirements, follow the Sequence detailed on Page 20. Remember to re-cycle the Key Switch if you make any changes to the chopper's Configuration. Otherwise follow the sequence detailed below :

- 1) Select the Options required. (Page 19).
- 2) Select and set the Battery Voltage.
- 3) Confirm correct installation of all wires. Use the Console's TESTER function to assist.
- 4) Perform the accelerator signal acquisition procedure using the Console "PROGRAM VACC". Procedure is detailed on Page 36.
- 5) Set the TRACTION IMAX Current, taking into account any Boost requirements. Use Table on Page 23.
- 6) Set the Acceleration Delay requirements for the machine. Test the parameters in both directions.
- 7) Set the CREEP level starting from level 0. The machine should just move when the accelerator microswitch is closed. Increase the Level accordingly.
- 8) Set the Speed Reductions as required. Make adjustments to CUTBACK SP.1, 2, 3. Check the performance with the accelerator pedal totally depressed. If the machine is a forklift, check the performance with and without load.
- 9) RELEASE BRAKING. Operate the machine at full speed. Release the accelerator pedal. Adjust the level to your requirements. If the machine is a forklift, check the performance with and without load.
- 10) INVERSION BRAKING. Operate the machine at 25% full speed. Whilst travelling INVERT the Direction Switch. Set a soft Level of Inversion Braking. When satisfactory, operate the machine at Full Speed and repeat. If the machine is a Forklift, repeat the tests and make adjustments with and without load. The unladen full speed condition should be the most representative condition.
- 11) PEDAL BRAKING (If used). Operate the machine at full Speed. Press the Pedal Brake. Set braking level to your requirements.
- 12) Set MAX SPEED FORW.
- 13) Set MAX SPEED BACK (Reverse).
- 14) Set the NOM FIELD CURR. (Nominal Field Current) of the drive motor making reference to information given on the motor nameplate.
- 15) Set WEAK DROPOUT (Field Weakening Drop Out Level) according to the requirements of the application.
- 16) If used , set the levels of SEAT MICRO DELAY, HYDRO TIME, BACKING TIME, BACKING SPEED, to levels as required.

Parameters are described in Page 21.

6 SEM 2 DIAGNOSTICS

As described in the Chopper Diagnostics on Page 9, the following listing shows likely problems associated with the Flashing RED LED.

N° FLASHES	MESSAGE	NOTES
1	LOGIC FAILURE	Problem with Logic, or General Contactor.
1	MICRO ST6215 KO	Problem with the Safety circuit of Microprocessor.
1	EEPROM KO	Problem with EEPROM or logic.
2	INCORRECT START	Starting sequence for travel not correct.
2	HANDBRAKE	Switch Open or Failed.
2	FORW+ BACK	Double Running request
3	CAPACITOR CHARGE	Problem in Power Block.
3	VMN NOT OK VMN	Problem with Chopper.
3	VFIELD NOT OK	Problem with Field Voltage
4	VACC NOT OK	Potentiometer Wiper Voltage too High.
4	PEDAL WIRE KO	Problem in the wiring of Foot Pedal.
5	NO FIELD CUR.	Open Circuit Field Winding or failure of the Field Current Sensor.
5	HIGH FIELD CUR.	Incorrect connection of Field Winding or failure of the Field Current Sensor.
5	STBY I HIGH	Problem with Armature Current Sensor at rest.
5	I= 0 EVER	Open circuit Armature loop or problem with Armature Current Sensor.
6	CONTACTOR DRIVER	Problem with a Contactor Driver in logic.
6	COIL SHORTED	Short Circuit of Contactor Coil.
6	DRIVER SHORTED	Short Circuit of Driver supplying the Main Contactor.
6	CONTACTOR CLOSED	Main Contactor contacts CLOSED. Contacts may be welded or mechanical failure has occurred.
7	MOTOR TEMPERAT.	Motor Temperature Sensor has operated.
7	TH. PROTECTION	Thermal Protection of the chopper has occurred. Temperature was either higher than 77°C, or lower than -10°C.
32	BATTERY LOW	Discharged Battery.

6.1 ANALYSIS OF ALARMS DISPLAYED ON THE CONSOLE

- 1 LOGIC FAILURE #1
During the initial diagnosis the main Microprocessor performs a check of the Main Contactor's control circuit, and verifies the condition. If this is not correct this Alarm is generated.
- 2 MICRO ST6215 KO
During the initial diagnosis the main Microprocessor tests and verifies the operation of the safety microprocessor. If not correct this Alarm is generated.
Possible causes:
 - a) Failure of the safety Microprocessor.
 - b) The safety Microprocessor has established a condition of danger and has disabled operation of the Main Contactor.
- 3 EEPROM KO
Fault in the area of memory where the adjustment parameters are stored. This Alarm inhibits machine operation. If the fault continues when the Key Switch is recycled, replace the logic. If the fault disappears, the previously stored Parameters will have been replaced by the default parameters.
- 4 INCORRECT START
Alarm generated by an incorrect Starting Sequence. Possible causes:
 - a) The ENABLE microswitch has welded or failed.
 - b) Error in the starting sequence from the operator.
 - c) Error in the wiring.
- 5 HANDBRAKE
Hand Brake Switch operated during travel.
- 6 FORW+ BACK
This check is made continually. The Alarm is generated when forward and reverse directions are requested simultaneously. Possible causes:
 - a) Incorrect Wiring.
 - b) Welding or Failure of a direction switch.
 - c) Incorrect operation from the operator.
- 7 CAPACITOR CHARGE
This check is made during the initial diagnosis. This Alarm is generated if the Capacitors are not charged within 500ms after the Key Switch is closed. Probable cause is failure inside the power block.
- 8 VMN NOT OK
This test is performed at rest, with the general Contactor Closed, and also during operation. At rest if VMN is lower than battery voltage this Alarm is generated. During operation this Alarm is generated if VMN doesn't follow the duty-cycle of the chopper. Possible causes:
 - a) Incorrect Motor connection.
 - b) Frame fault of motor to chassis.
 - c) Defect in the power unit.

9 VFIELD NOT OK

This test is made at standby with the Main Contactor open. In this condition the voltage on both the connections of field must be to around $1/2 V_{Batt}$. This alarm is generated if the field voltage is different from this value. Possible causes:

- a) Frame fault on the motor to chassis.
- b) Incorrect connection of the field winding to the chopper.
- c) Failure of the chopper in the section relative to the field.

10 VACC NOT OK

This Alarm is generated if the accelerator output voltage differs more than 2V from the acquired minimum during the PROGRAM VACC. Possible causes:

- a) The track of the potentiometer has become open.
- b) The potentiometer is not wired correctly.
- c) The potentiometer itself is defective.
- d) The values set in PROGRAM VACC routine have not remained or made correctly.

11 PEDAL WIRE KO

This Alarm is generated if potentiometer or wiring fault is detected. (NPOT or PPOT are open circuit).

12 STBY I HIGH

This test is made during the initial diagnosis and at standby. The test verifies that the current is zero. This Alarm disables the machine. Possible causes:

- a) Defective current sensor.
- b) Logic failure. First replace the logic. If fault remains replace the power unit.

13 I = 0 EVER

This check is made during travel. If the current is not higher than a preset minimum value, this Alarm is generated and the machine disabled. Possible causes: see STBY I HIGH. Check the motor armature (brush connections).

14 HIGH FIELD CURR, NO FIELD CUR

Problem detected with the field winding current. Possible causes:

- a) Failure of the field current sensor.
- b) Field cables not connected or incorrectly connected.
- c) Open circuit Field Winding.
- d) Failure of the Field Power Unit.
- e) The Alarm No FIELD CURR could also be generated if the safety microprocessor detects a problem.

15 CONTACTOR DRIVER, COIL SHORTED, DRIVER SHORTED

These Alarms are generated if there is a problem with the Main Contactor. Possible causes:

- a) the coil of the contactor is either short-circuit, open circuit, or not connected
- b) The Contactor Coil Driver is short-circuit.
- c) defect in the wiring to the contactor, or logic failure.

16 CONTACTOR CLOSED

This check is made during the initial diagnosis. With the coil of the Main Contactor de-energised, the capacitors should not be charged, unless there is divert resistor across the power poles. Possible causes:

- a) The contactor power poles are welded .
- b) This alarm could be generated if the Main Contactor has opened, but there is a problem with either the field circuit, or a problem detected by the safety micro-processor.

17 MOTOR TEMPERAT

The temperature of the motor has become higher than the threshold set by the motor sensor. When this Alarm is generated, the motor speed is reduced. If this alarm appears with a cold motor:

- a) Check the connection to the temperature sensor.
- b) Check that there is no problem with the temperature sensor.
- c) Check there is no problem with the motor temperature.

18 TH PROTECTION

If the temperature of the chopper rises higher than 77°C, this alarm is generated. The chopper current is reduced in proportion to the increase in temperature. At 92°C the chopper totally stops. If the temperature of the chopper is < -10°C, this Alarm is also generated and the current is reduced by 80 %. If this alarm is displayed when the chopper is temperature is the same as ambient or better than zero degrees:

- a) Check the connection of the temperature sensor.
- b) The temperature sensor may be defective.
- c) The logic may be defective.

19 BATTERY LOW

This Alarm is generated when the battery becomes 50% discharged from the

nominal value.

6.2 TESTER. DESCRIPTION OF THE FUNCTIONS

The most important input or output signals can be measured in real time using the TESTER function of the console. The Console acts as a multimeter able to read voltage, current and temperature. The following definition listing shows the relative measurements :

- 1) **BATTERY VOLTAGE:** level of battery voltage measured at the input to the key switch.
- 2) **BATTERY CHARGE:** the percentage Charge level of the battery.
- 3) **MOTOR VOLTAGE:** the voltage appearing across the drive motor. It is measured between B+ and VMN.
- 4) **MOTOR CURRENT:** the current flowing in the drive motor armature.
- 5) **FIELD CURRENT:** the current flowing in the drive motor field winding.
- 6) **VMN:** the voltage effectively dropped across the MOS. It is measured between -BATT and VMN.
- 7) **TR. CHOPPER TEMP:** the temperature measured on the aluminum heat sink holding the MOSFET devices.
- 8) **ACCELERATOR:** the voltage of the accelerator potentiometer wiper (CPOT). The voltage level is shown on the Left Hand Side of the Console Display and the value in percentage is shown on the Right Hand Side.
- 9) **FORWARD SWITCH:** the level of the Forward direction digital entry MA (pin E3).
ON/+ VB = active entry of closed switch.
OFF / GND = non active entry of open switch.
- 10) **BACKWARD SWITCH:** the level of the Reverse direction digital entry MI (pin E2).
ON/+ VB = active entry of closed switch.
OFF / GND = non active entry of open switch.
- 11) **ENABLE SWITCH:** the level of Enable Switch digital input.
ON/+ VB = active entry of closed switch.
OFF / GND = non active entry of open switch.
- 12) **SEAT SWITCH:** the level of the Seat Microswitch digital entry (pin E6).
ON/+ VB = active entry of closed seat switch.
OFF/ GND = non active entry of open seat switch.
- 13) **HAND BRAKE:** the level of the Handbrake Microswitch (pin B5).
ON/+ VB = active entry of Handbrake switch.
OFF/ GND = non active entry of microswitch.
- 14) **CUTBACK SWITCH 1:** the level of the Speed Reduction 1 Microswitch (pin E4).
ON/ +12 = active entry of speed reduction microswitch.
OFF/ GND = non active entry of microswitch.
- 15) **CUTBACK SWITCH 2:** the level of the Speed Reduction 2 Microswitch (pin B4).
ON/ +12 = active entry of speed reduction microswitch.
OFF/ GND = non active entry of microswitch.

- 16) CUTBACK SWITCH 3:** the level of the Speed Reduction 3 Microswitch (Pin L4).
ON/ +12 = active entry of speed reduction microswitch.
OFF / GND = non active entry of microswitch.
- 17) BRAKE SWITCH:** the level of the Pedal Brake Microswitch (pin E5).
ON/+ VB = active entry of Brake pedal microswitch.
OFF / GND = non active entry of microswitch.
- 18) BACKING FUNCTION:** the level of the Backing Microswitch inputs (pins L2 or L3).
ON/+ VB = active switch entry.
OFF / GND = non active switch entry.
- 19) MOTOR TEMPERAT.:** the level of the Motor Temperature Sensor (pin E7).
ON / +VB = temperature of the motor is too high.
OFF/ GND = temperature of the motor within the limits. Sensor is not operating.

Flow Chart showing how to use the TESTER function of the Digital Console.

- 1) Opening Zapi Display.
- 2) Press ENTER to go into the General menu.
- 3) The Display will show :
- 4) Press ROLL UP or ROLL DOWN button until TESTER MENU appear on the display.
- 5) The Display shows :
- 6) Press ENTER to go into the TESTER function.
- 7) The first variable to be tested is shown on the Display.
- 8) Press either ROLL UP or ROLL DOWN buttons until your desired variable for measurement appears on the Display.
- 9) When you have finished, Press OUT.
- 10) The Display shows :
- 11) Press OUT again. Console now shows the Opening Zapi Display.

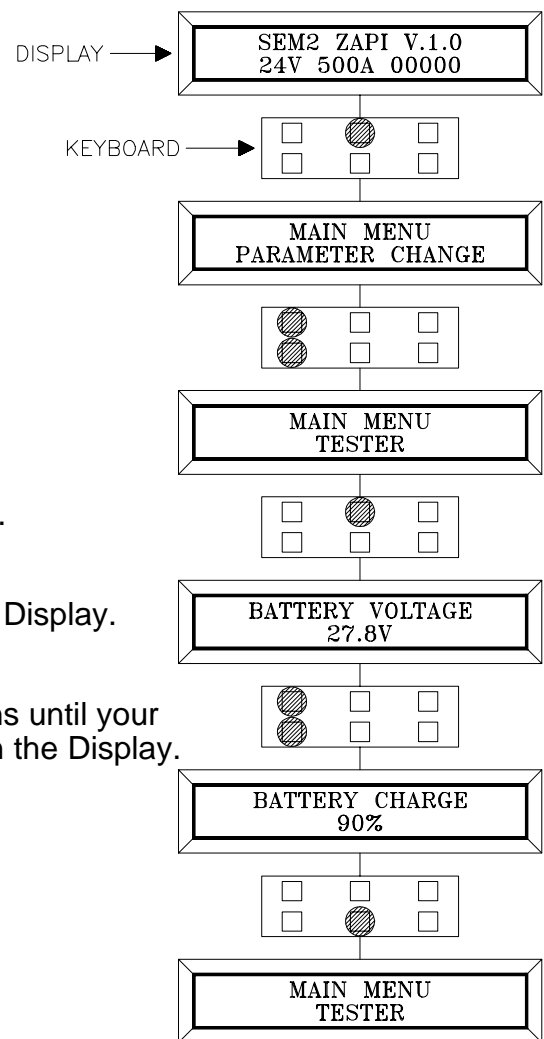

Remember it is not possible to make any changes using TESTER. All you can do is measure as if you were using a pre-connected multimeter.

6.3 DESCRIPTION OF THE CONSOLE SAVE FUNCTION

The SAVE function allows the operator to transmit the Parameter values and Configuration data of the chopper into the Console memory. It is possible to load 64 different programmes.

The information saved in the Console memory can then be reloaded into another chopper using the RESTORE function.

The data that is available via the SAVE function is as follows:

- All Parameter Values (PARAMETER CHANGE).
- Options (SET. OPTIONS).
- The Level of the Battery (ADJUST BATTERY).

Flow Chart showing how to use the SAVE function of the Digital Console.

1) Opening Zapi Display.

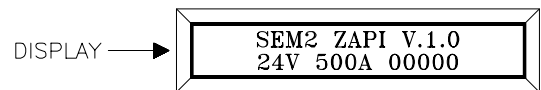

2) Press ENTER to go into the General menu.

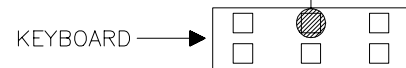

3) The Display will show :

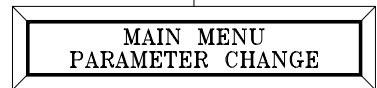

4) Press ROLL UP or ROLL DOWN button until SAVE PARAM. appears on the display

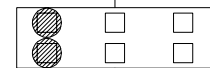

5) The Display will show :

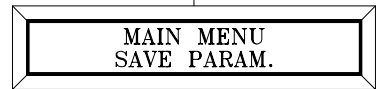

6) Press ENTER to go into the SAVE function.

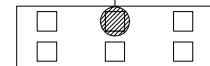

7) If this facility has been used before the type of chopper data stored appears on the top Main with a 2 digit reference.

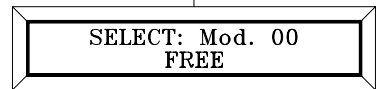

8) Keep pressing either ROLL UP or ROLL DOWN keys until the second Main indicates a FREE storage facility.

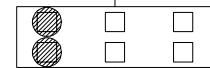

9) Press ENTER to commence SAVE routine.

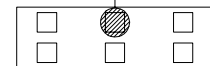

10) You can see the items that are being stored whilst the SAVE routine is happening.

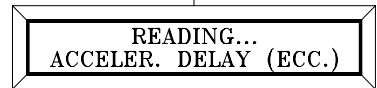

11) When finished, the Console shows :



13) Press OUT to return to the Opening Zapi Display.

6.4 DESCRIPTION OF CONSOLE RESTORE FUNCTION.

The RESTORE PARAM function allows transfer of the Console's stored data into the memory of the chopper. This is achieved in a fast and easy way using the method previously used with the SAVE PARAM. function.

The data that is available via the RESTORE PARAM. function is as follows :

- All Parameter Values (PARAMETER CHANGE).
- Options (SET OPTIONS)
- The level of the Battery (ADJUST BATTERY)

ATTENTION: When the RESTORE operation is made, all data in the chopper memory will be written over and replaced with data being restored.

Flow Chart showing how to use the RESTORE function of the Digital Console.

1) Opening Zapi Display.

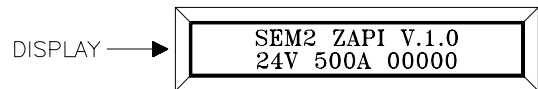

2) Press ENTER to go into the General menu.

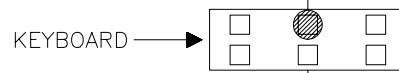

3) The Display will show :

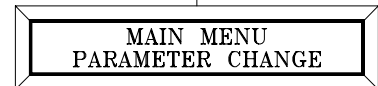

4) Press ROLL UP or ROLL DOWN button until RESTORE PARAM. appears on the display.

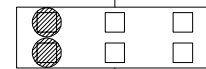

5) The Display will show :

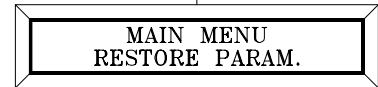

6) Press ENTER to go into the RESTORE PARAM. function.

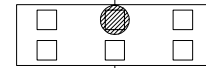

7) The Display shows the type of Model stored, with a Code Number.

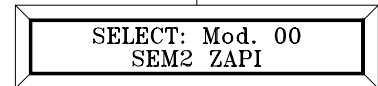

8) Keep pressing either ROLL UP and ROLL DOWN buttons until the desired model appears on the Display.

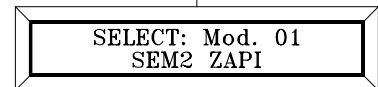
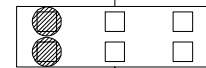

9) Press ENTER to commence the Restore operation.

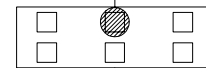

10) The Display will ask "ARE YOU SURE". Press ENTER for YES, or OUT for No.

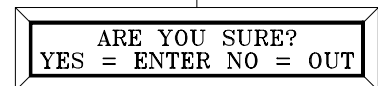

11) You can see the items that are being stored in the chopper memory whilst the RESTORE routine is happening.



12) When finished the Console displays :

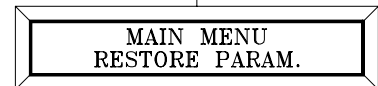

13) Press OUT to return to the Opening Zapi Display .

6.5 DESCRIPTION OF ALARMS MENU.

The microprocessor in the chopper remembers the last five Alarms that have occurred. Items remembered relative to each Alarm are : the code of the alarm, the number of times the particular Alarm occurred, the Hour Meter count, and the chopper temperature.

This function permits a deeper diagnosis of problems as the recent history can now be accessed.

Flow Chart showing how to use the ALARMS function via the Digital Console.

1) Opening Zapi Display.



2) Press ENTER to go into the General menu.



3) The Display will show :



4) Press ROLL UP or ROLL DOWN button until PARAMETER CHANGE appears on the display.



5) The Display will show:



6) Press ENTER to go into the ALARMS function.



7) The Display will show the most recent Alarm.

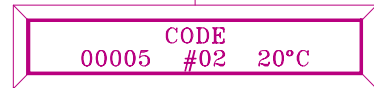

8) Each press of the ROLL UP button brings up following Alarms. Pressing ROLL DOWN returns to the most recent.

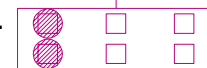

9) If an Alarm has not occurred, the Display will show: ALARM NULL.



10) When you have finished looking at the Alarms, press OUT to exit the ALARMS menu.

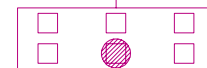

11) The Display will ask CLEAR LOGBOOK ?



12) Press ENTER for yes, or OUT for NO.

13) Press OUT to return to the Opening Zapi Display.

6.6 DESCRIPTION OF CONSOLE PROGRAM VACC FUNCTION.

This function looks for and remembers the minimum and maximum potentiometer wiper voltage over the full mechanical range of the pedal. It enables compensation for non symmetry of the mechanical system between directions.

The operation is performed by operating the pedal after entering the PROGRAM VACC function.

Flow Chart showing how to use the PROGRAM VACC function of the Digital Console.

1) Opening Zapi Display.



2) Press ENTER to go into the General Menu.



3) The Display will show :



4) Press ROLL UP or ROLL DOWN button until PROGRAM VACC appears on the display.

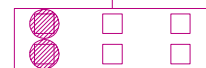

5) The Display will show :



6) Press ENTER to go into the PROGRAM VACC routine.



7) The Display will show the minimum and maximum values of potentiometer wiper output. Both directions can be shown.



8) Press ENTER to clear these values. Display will show 0.0.



9) Select Forward Direction, close any interlock switches that may be in the system.



10) Slowly depress the accelerator pedal (or tiller butterfly) to its maximum value. The new minimum and maximum voltages will be displayed on the Console plus an arrow indicating the direction.

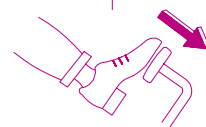

11) Select the Reverse Direction and repeat Item 10.



12) When finished, press OUT.

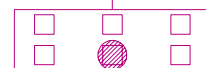

13) The Display will ask : ARE YOU SURE ?.



14) Press ENTER for yes, or OUT for NO.

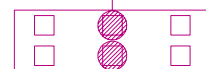

15) Press OUT again to return to the Opening Zapi Menu.

7 RECOMMENDED SPARE PARTS FOR SEM 2

<u>Part Number</u>	<u>Description</u>
C16504	Protected 300A Air Fuse.
C16503	Protected 200A Air Fuse
C16520	6.3A 20mm Control Circuit Fuse
P99060	Red LED
C12373	9 Way Molex Connector
C12372	8 Way Molex Connector
C12371	3 Way Molex Connector
C12370	2 Way Molex Connector
C12769	Insert for Molex Connectors
C29619	SW 180 24V CO Single Pole Contactor
C29610	SW 180 48V CO Single Pole Contactor

8 PERIODIC MAINTENANCE TO BE REPEATED AT TIMES INDICATED.

Check the wear and condition of the Contactors' moving and fixed contacts. Electrical Contacts should be checked every **3 months**.

Check the Foot pedal or Tiller microswitch. Using a suitable test meter, confirm that there is no electrical resistance between the contacts by measuring the volt drop between the terminals. Switches should operate with a firm click sound. Microswitches should be checked every **3 months**.

Check the Battery cables, cables to the chopper, and cables to the motor. Ensure the insulation is sound and the connections are tight. Cables should be checked every **3 months**.

Check the mechanical operation of the pedal or tiller . Are the return springs ok. Do the potentiometers wind up to their full or programmed level. Check every **3 months**.

Check the mechanical operation of the Contactor(s). Moving contacts should be free to move without restriction. Check every **3 months**.

Checks should be carried out by qualified personnel and any replacement parts used should be original. Beware of NON ORIGINAL PARTS.

The installation of this electronic controller should be made according to the diagrams included in this Manual. Any variations or special requirements should be made after consulting a Zapi Agent. The supplier is not responsible for any problem that arises from wiring methods that differ from information included in this Manual.

During periodic checks, if a technician finds any situation that could cause damage or compromise safety, the matter should be brought to the attention of a Zapi Agent immediately. The Agent will then take the decision regarding operational safety of the machine.

Remember that Battery Powered Machines feel no pain.

NEVER USE A VEHICLE WITH A FAULTY ELECTRONIC CONTROLLER.